

nickelodeon™  
TEENAGE MUTANT NINJA  
TURTLES™



**Transforming Turtle Mech**  
**Le Véhicule-Robot Transformable des Tortues**  
**Tortuga mecánica transformable | Robô Tartaruga Transformável**  
**Robot Tartaruga d'Attacco | Verwandelbarer Turtle Mech**  
**Chodzący żółw transformer | Трансформация механизма черепашки**

2

Includes 3 figures, others sold separately. | Contient 3 figurines. Autres figurines vendues séparément. | Incluye 3 figuras. Las demás figuras se venden por separado. | Inclui 3 figuras, restantes vendidas em separado. | Include 3 personaggi, gli altri sono in vendita separatamente. | Enthält 3 figuren. Andere abgebildete figuren separat erhältlich. Einige artikel werden in nicht allen ländern vertrieben. | W zestawie 3 figurki, pozostałe sprzedawane oddzielnie. | Inclusief 3 figuren. Andere figuren apart verkrijgbaar. | В комплект входят 3 фигурки, остальное продается отдельно.



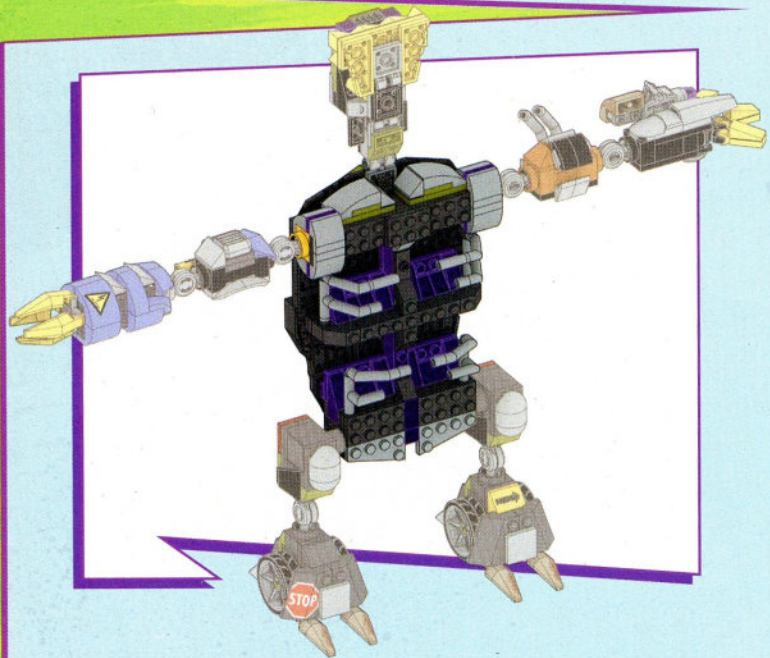

**50**

- 1x
- 2x
- 1x
- 1x
- 1x
- 1x



**51**

- 1x
- 1x
- 1x

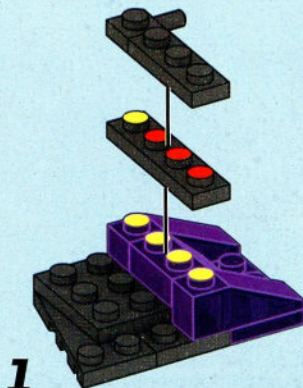

**1**

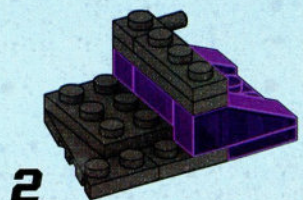

**2**

**52**

- 1x
- 2x
- 1x
- 1x
- 1x
- 1x
- 1x

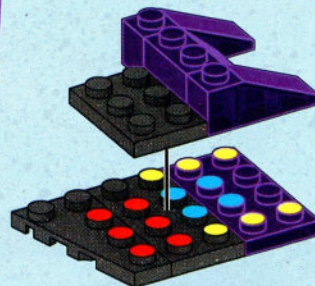

**53**

- 1x
- 1x
- 1x

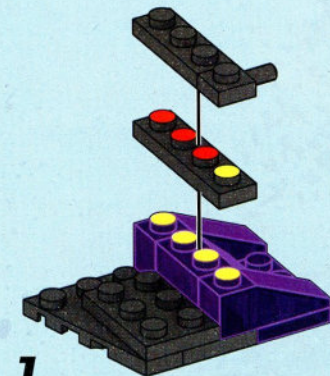

**1**

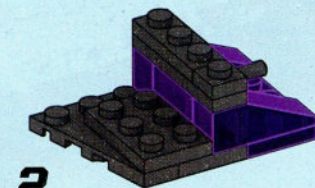

**2**

54

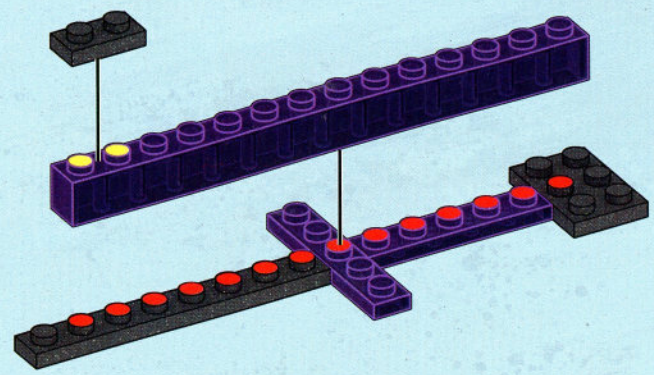
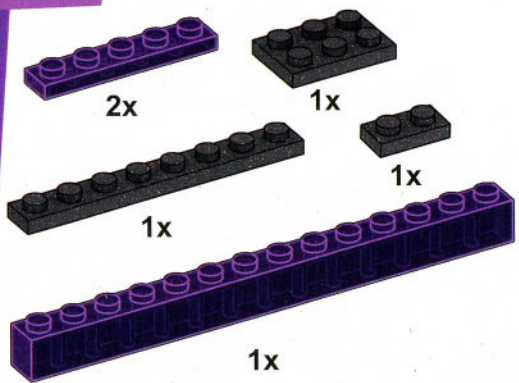

55

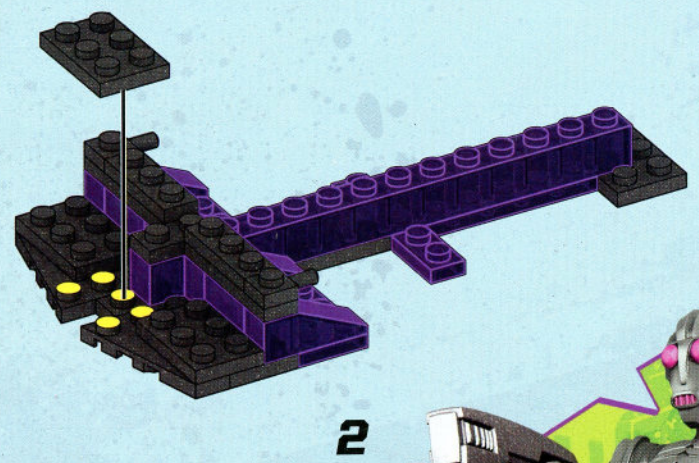
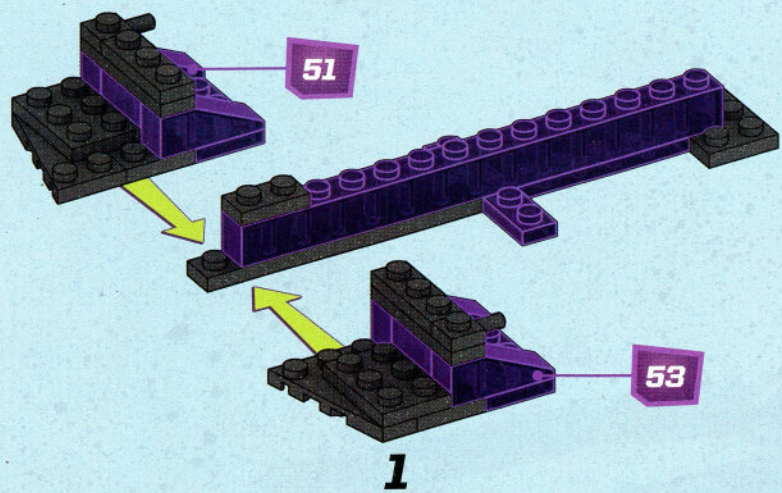
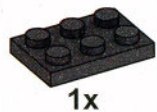

56

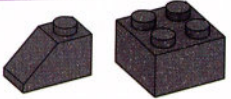

1x

2x

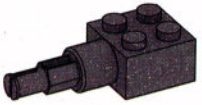

2x

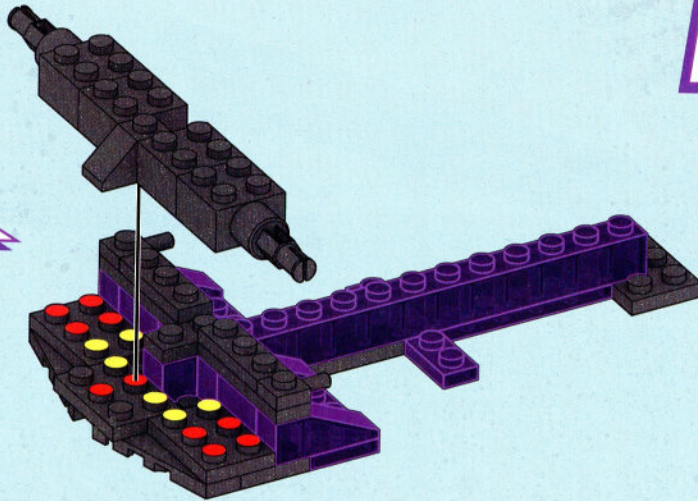

57



1x



2x



2x

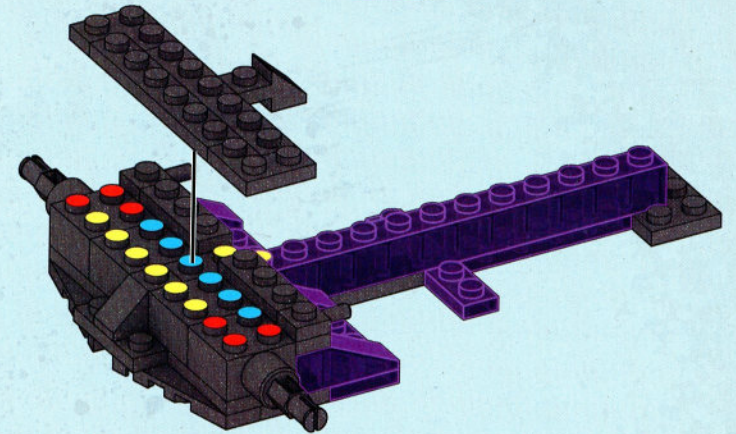

58



1x

1x

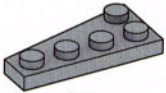

1x

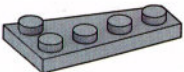

1x



2x

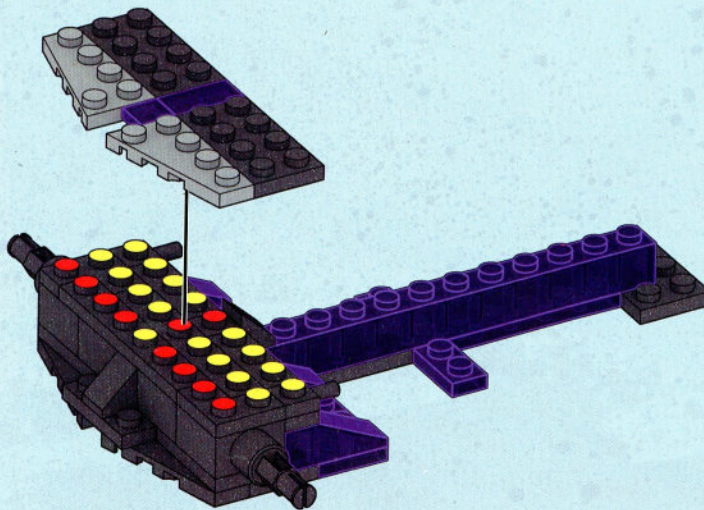

59



2x



2x



4x



4x



2x



2x

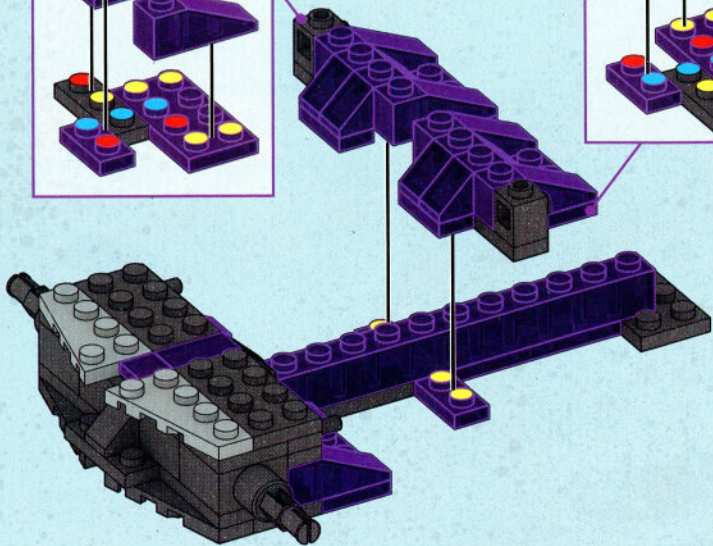
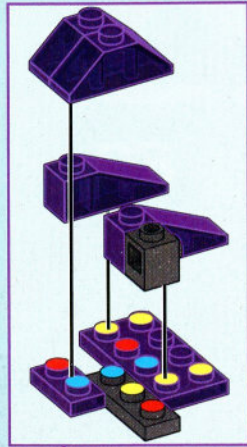
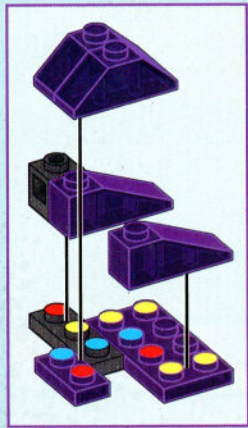

60



4x



2x



1x

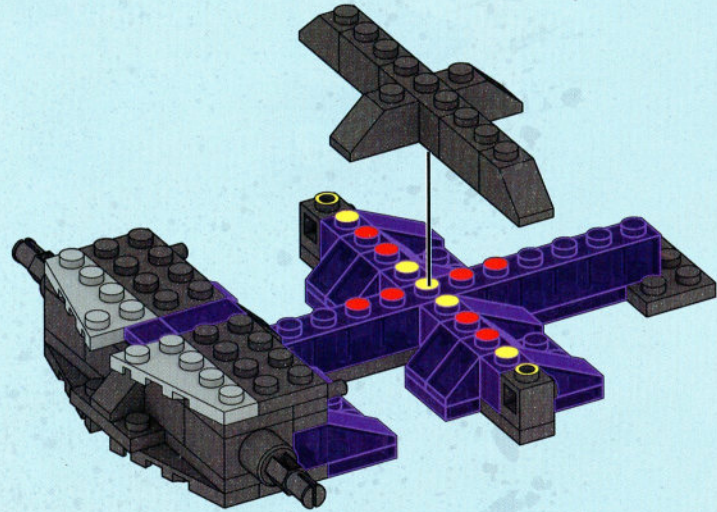

**61**

1x



1x

1x



1x

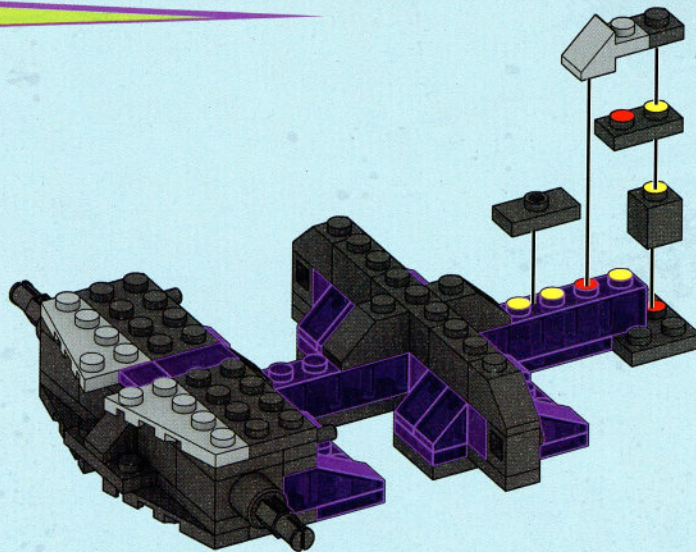

**1**

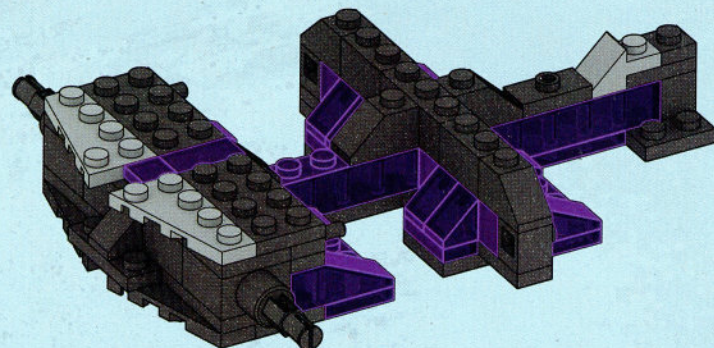

**2**

**62**

2x



4x



4x

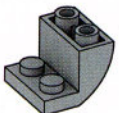

2x

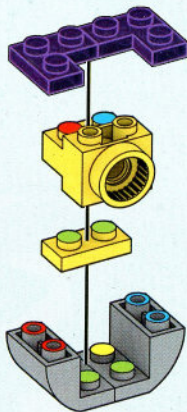
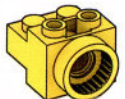

**1**

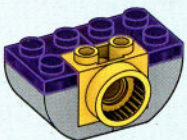

**2**

x2

**63**

2x



1x



1x



1x

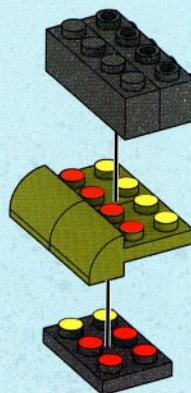

**1**

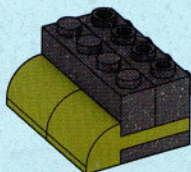

**2**

**64**

2x



1x



1x



1x

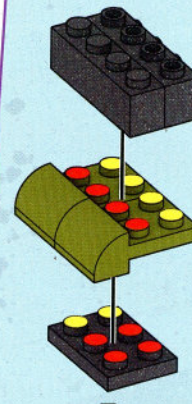

**1**

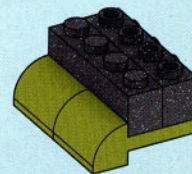

**2**

65

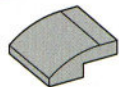

2x

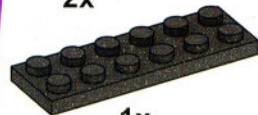

1x

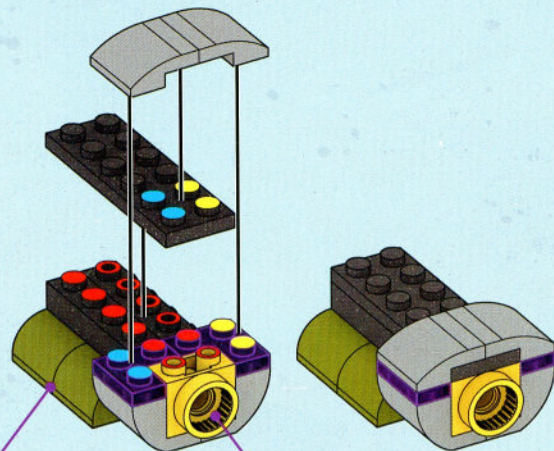

63

1

62

2

66

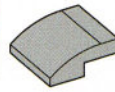

2x

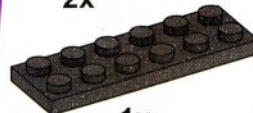

1x

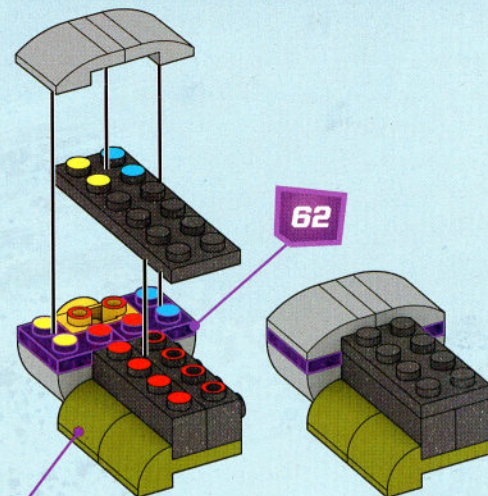

62

64

1

2

67



1x

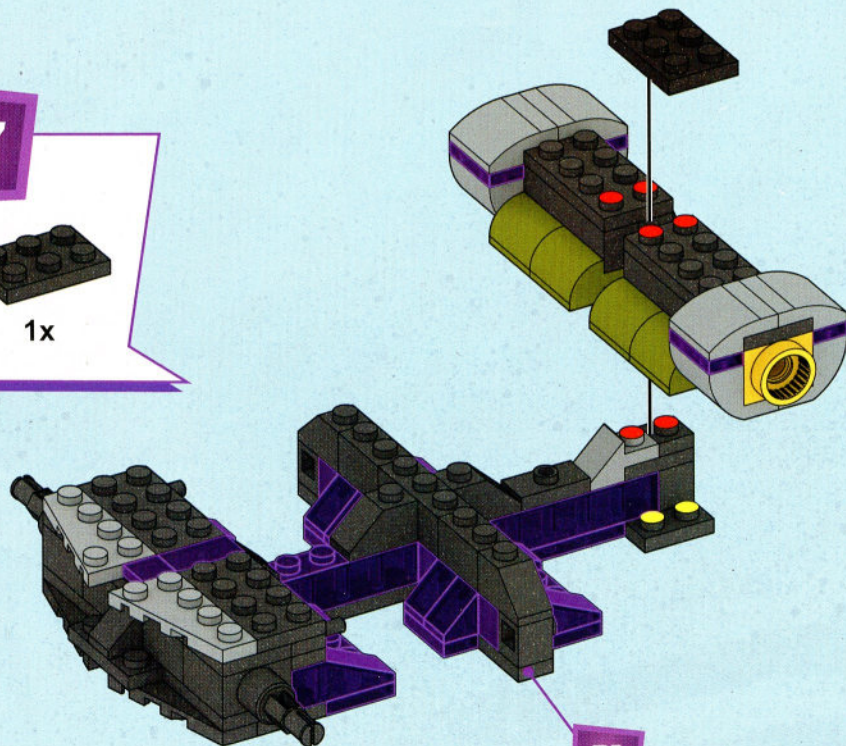

1

61

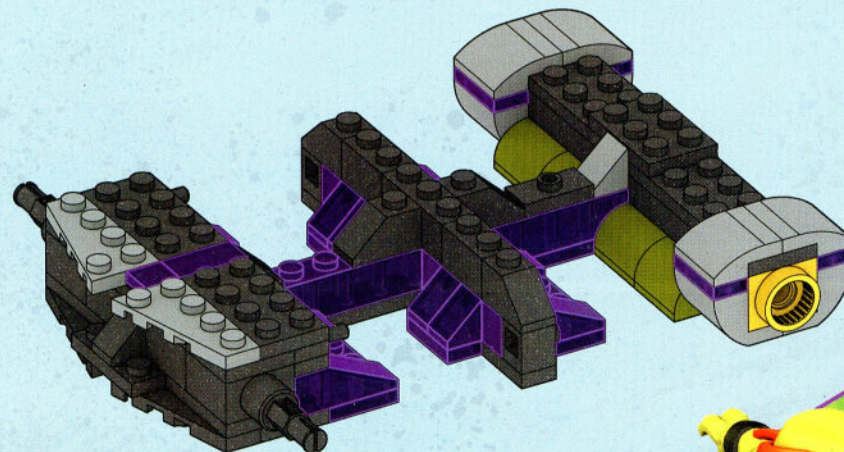

2



68

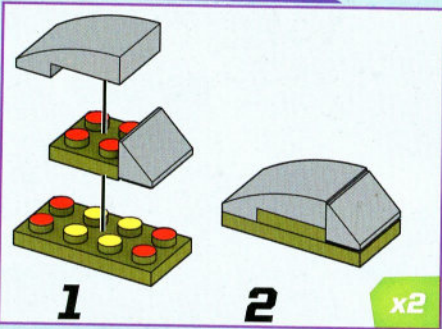
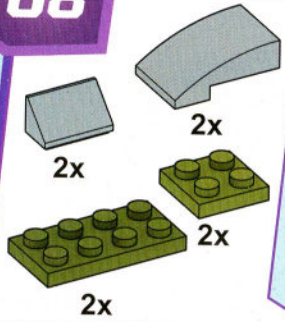

69

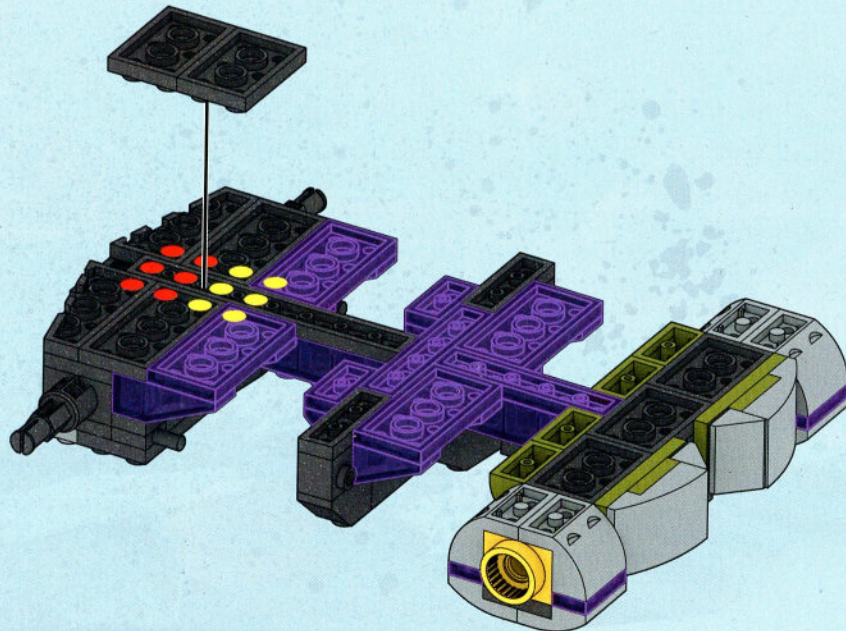
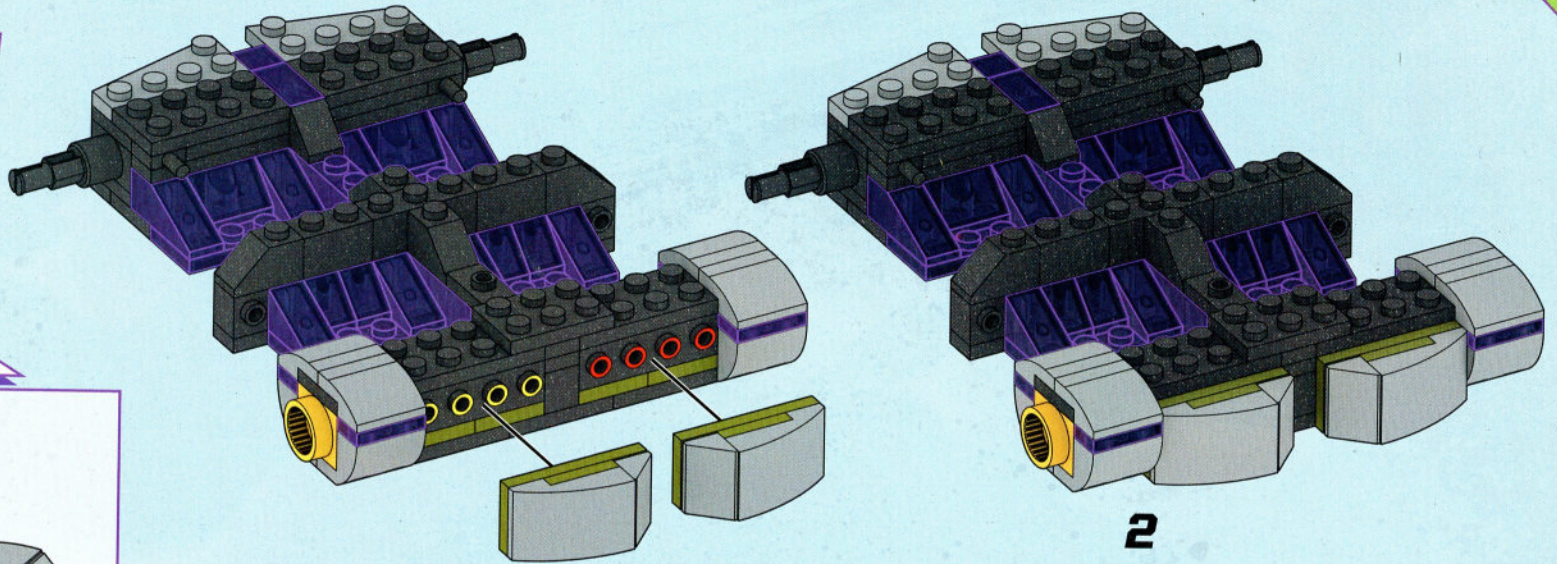
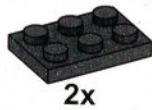



70

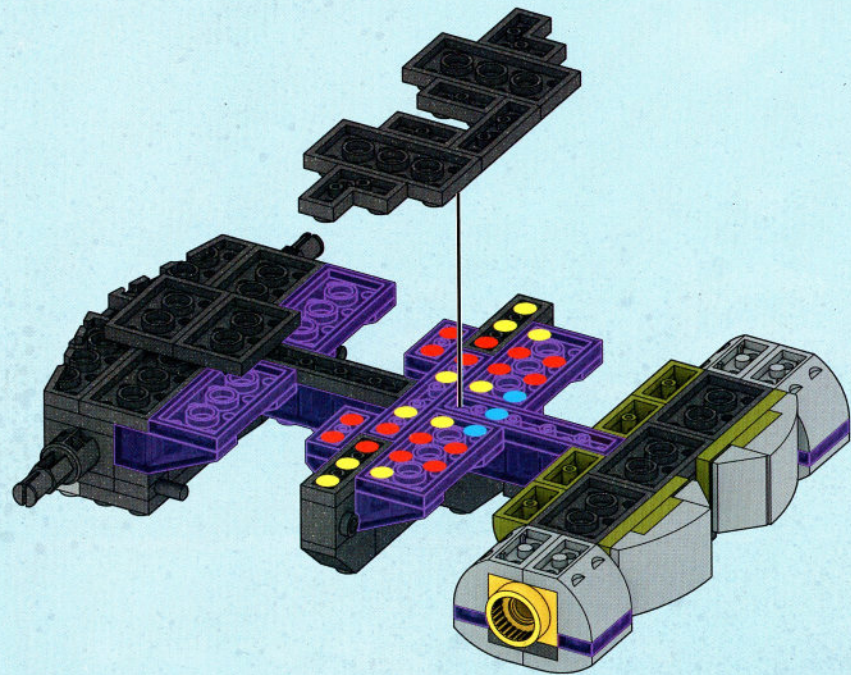
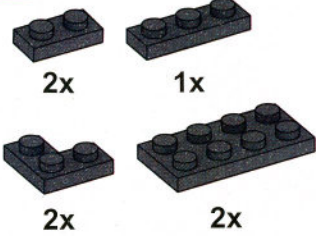

71

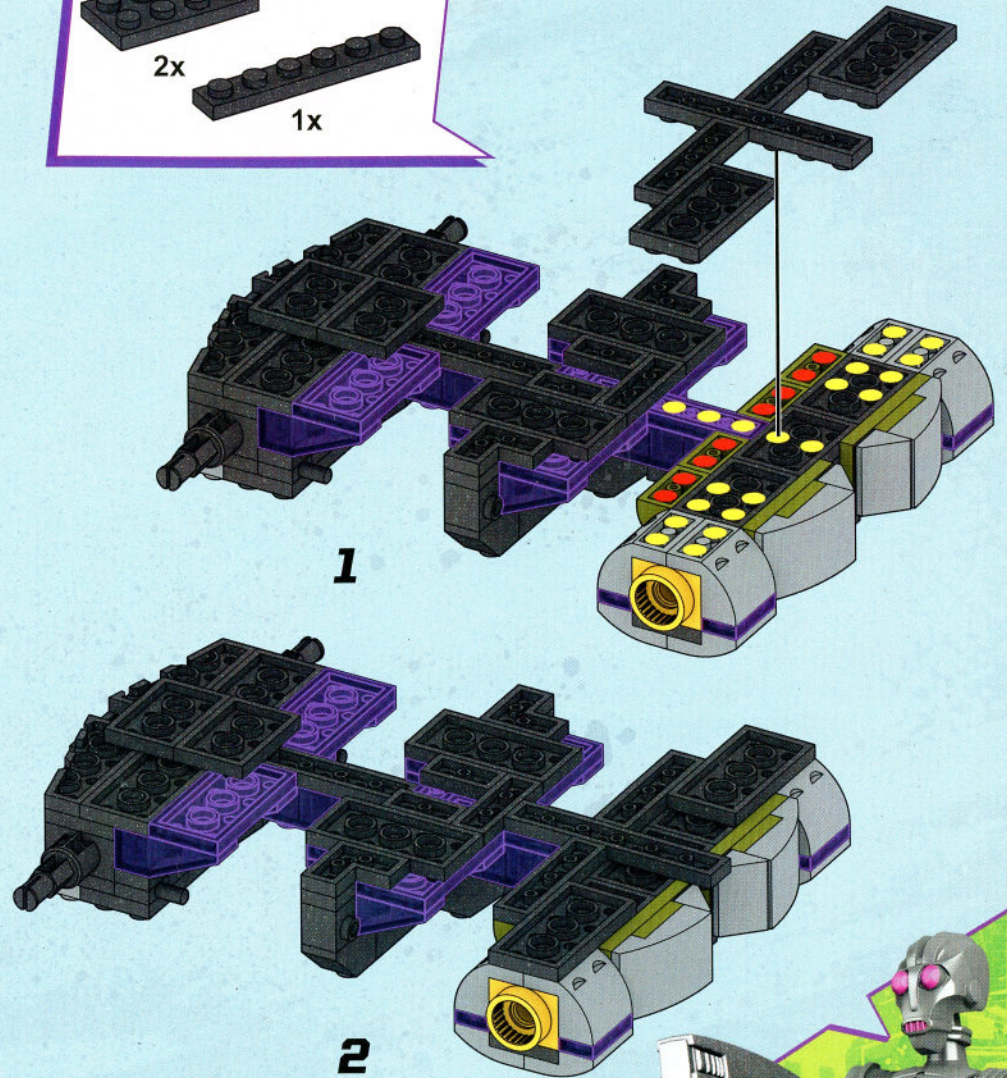
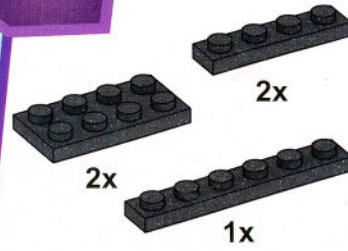

72



2x



2x



4x



2x



4x



2x



1

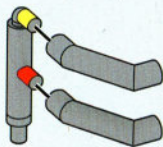

2

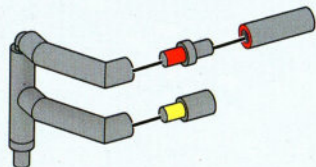

3

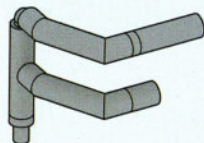

4



1



2

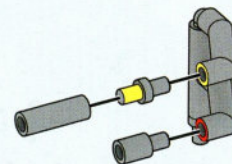

3

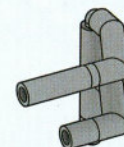

4

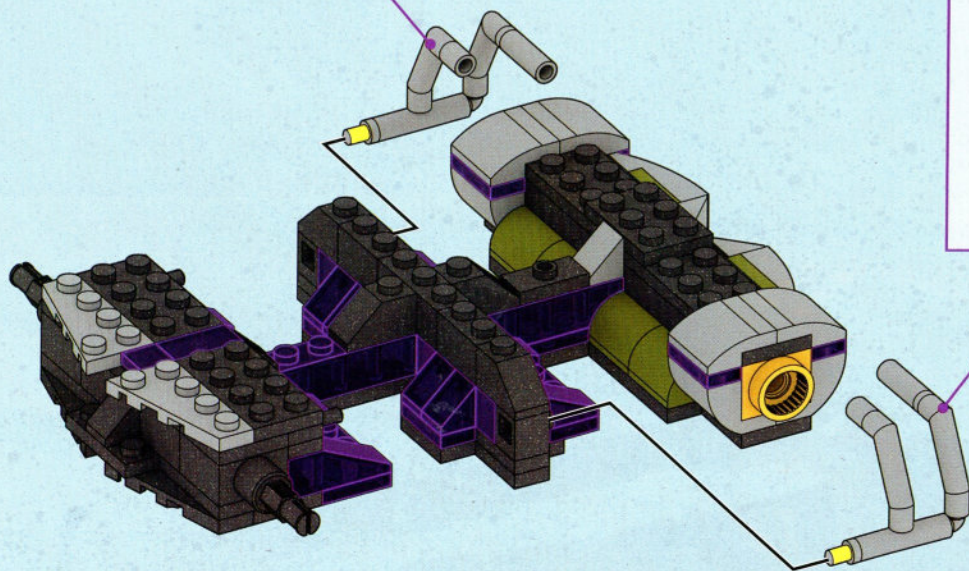

73

2x 2x

2x 2x

2x

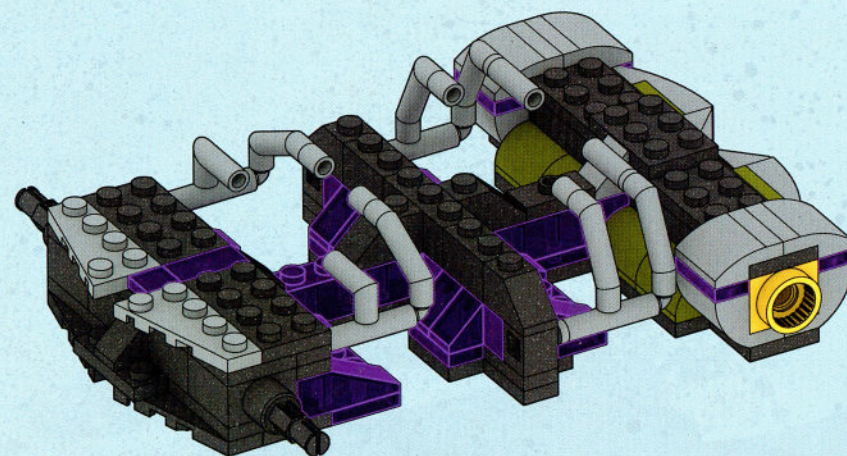
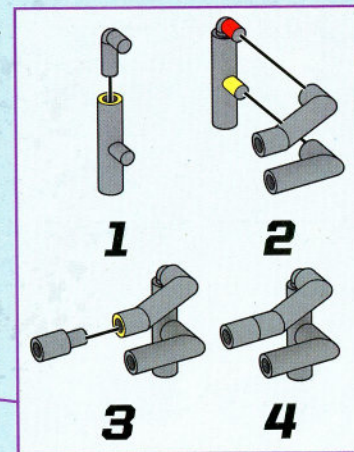
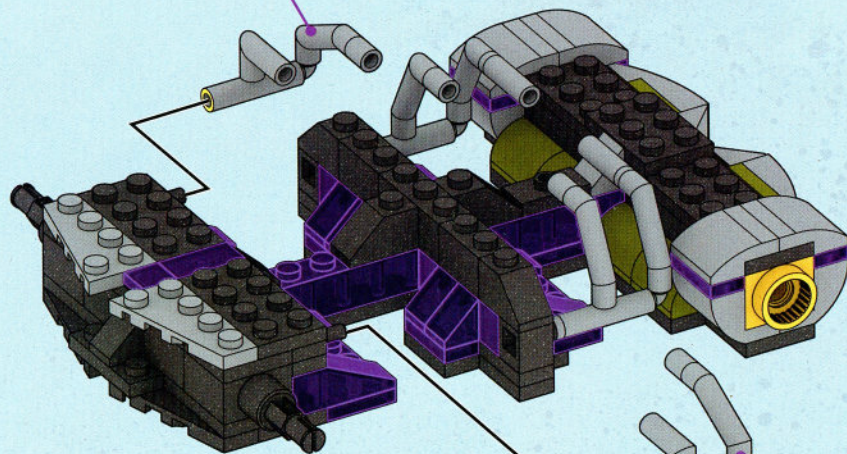
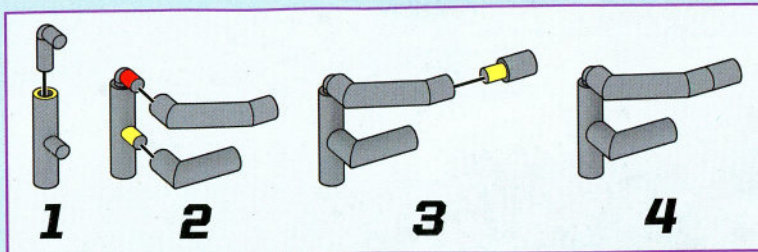

74

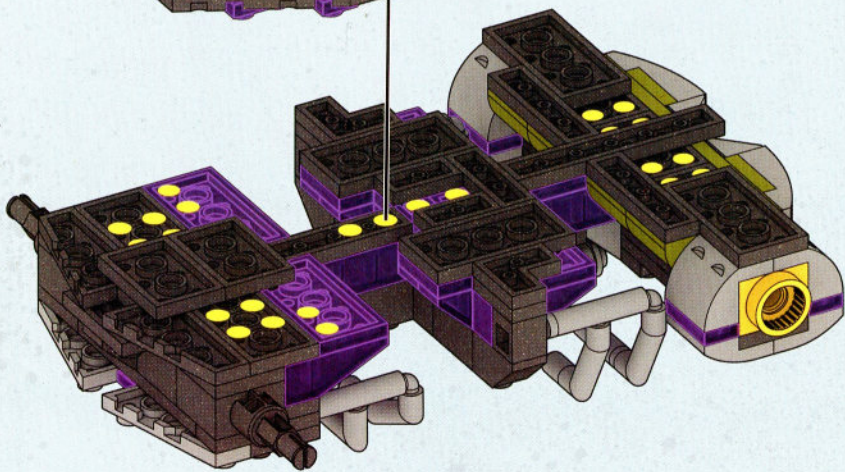
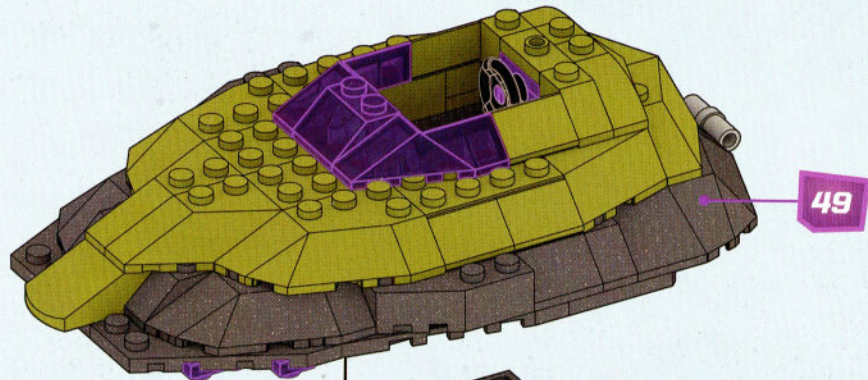

1

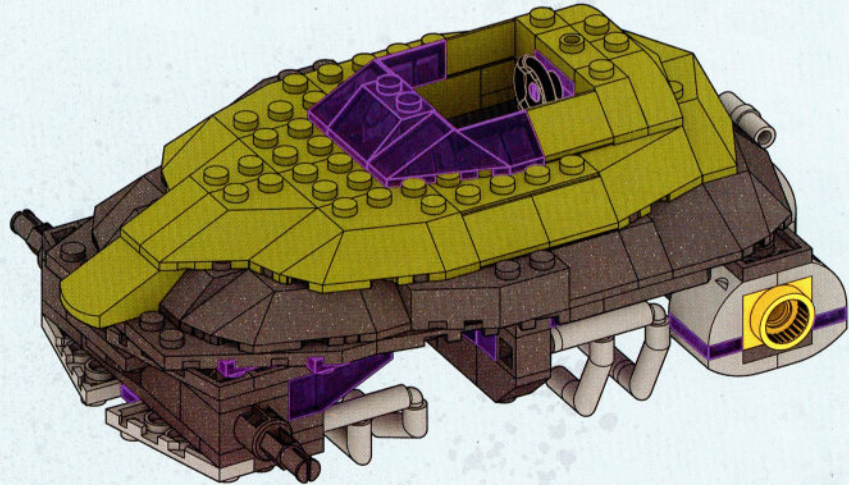

2

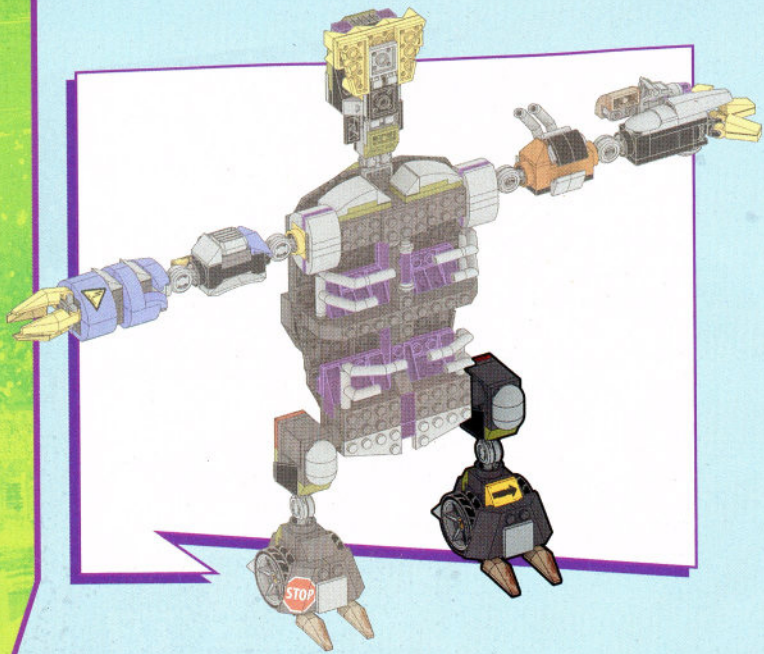

75

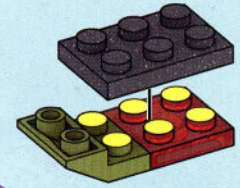
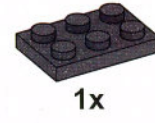
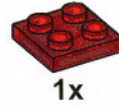
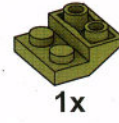

76

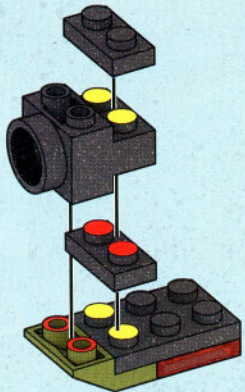

77

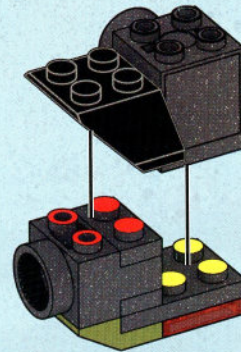
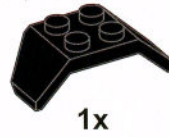

78

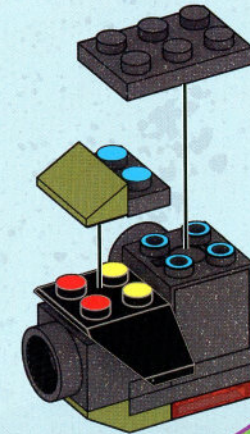
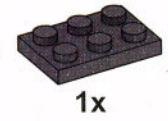
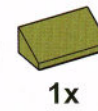

79



2x



1x

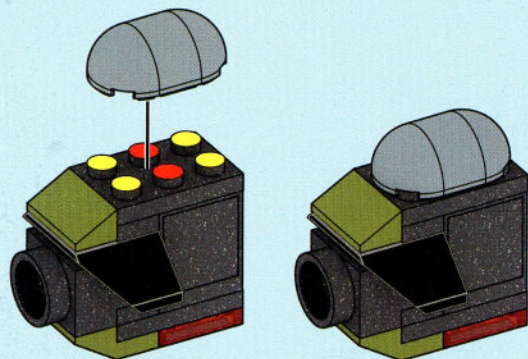

1

2

80



1x



1x



1x

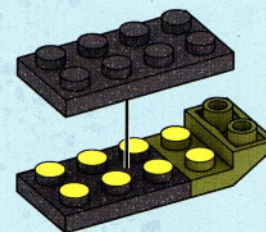

81



1x



1x

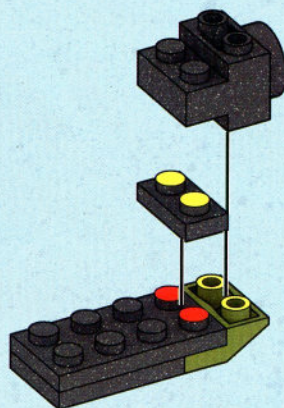

82



1x



2x



1x

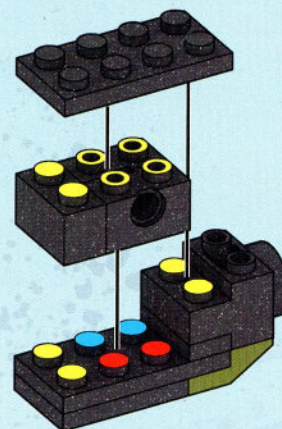

83

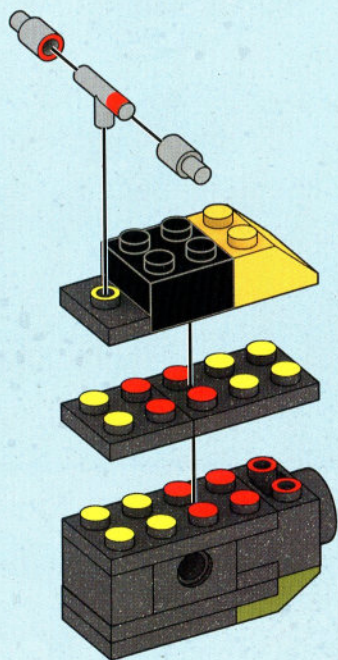
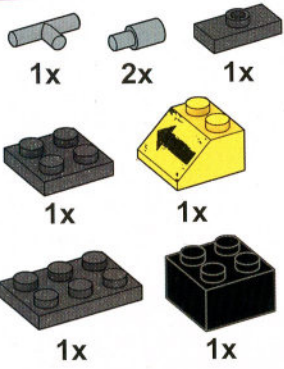

84

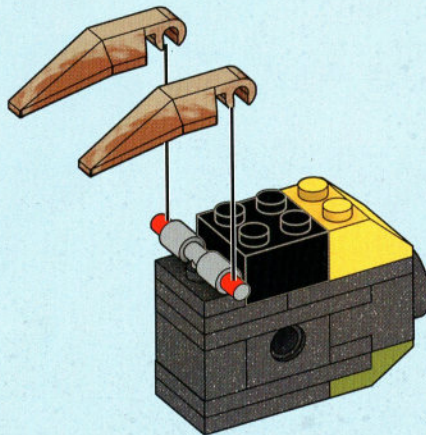
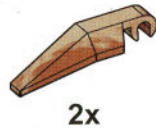

85

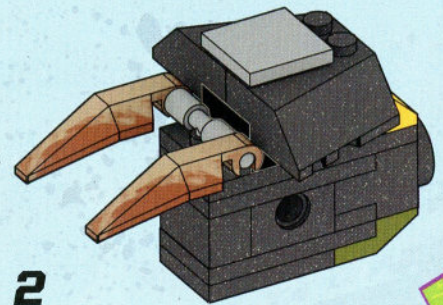
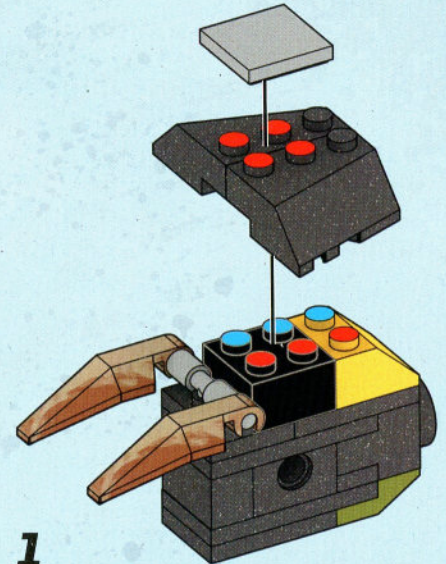
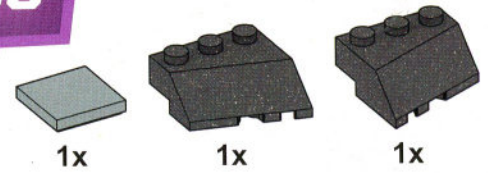

86

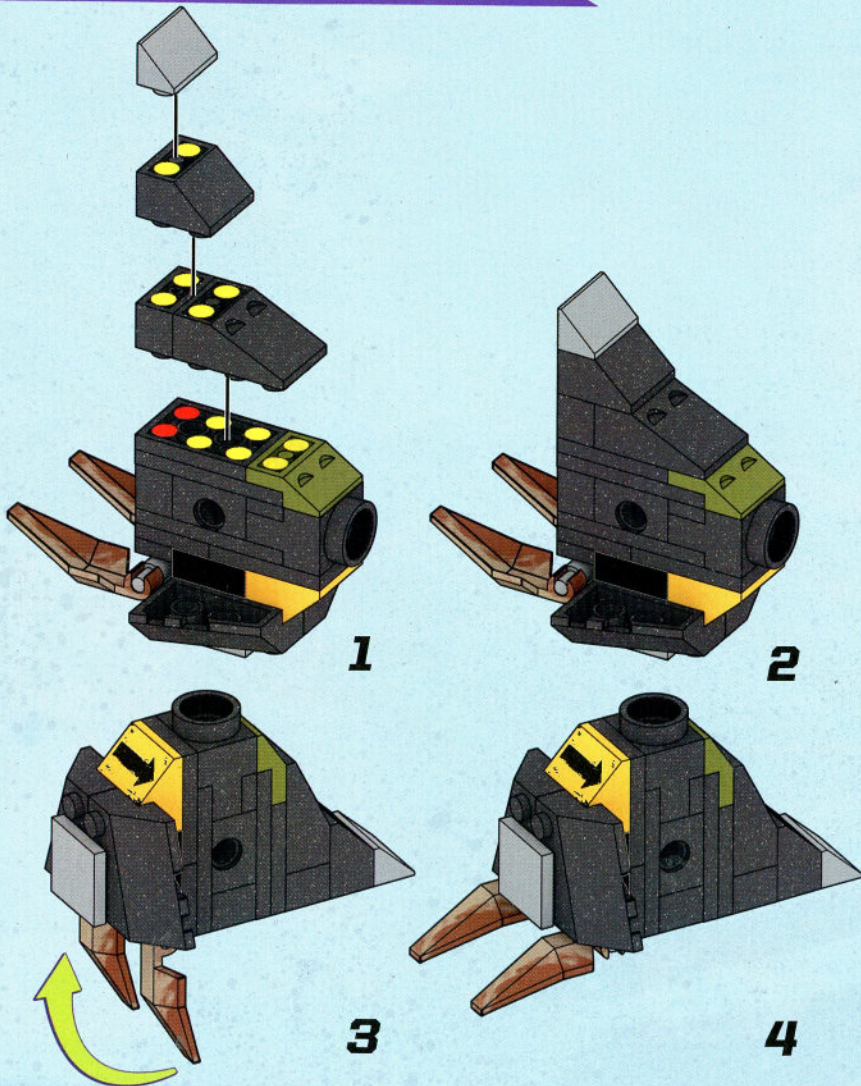
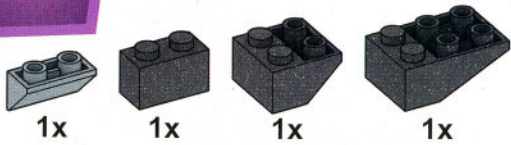

87

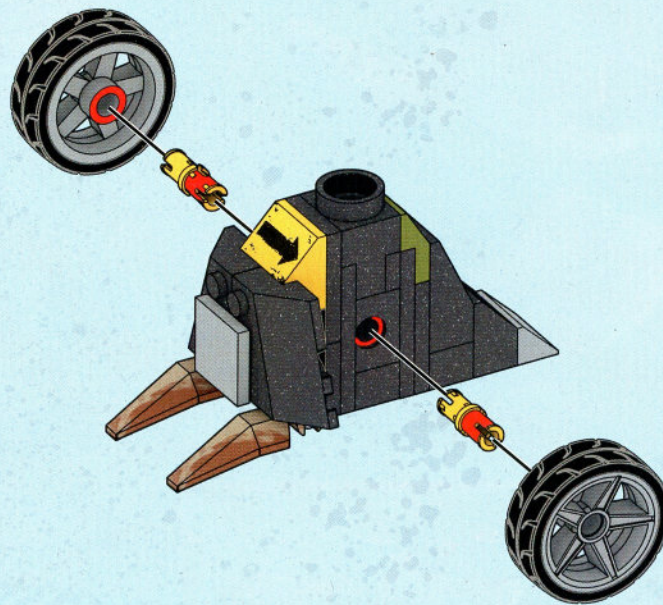



88



1x

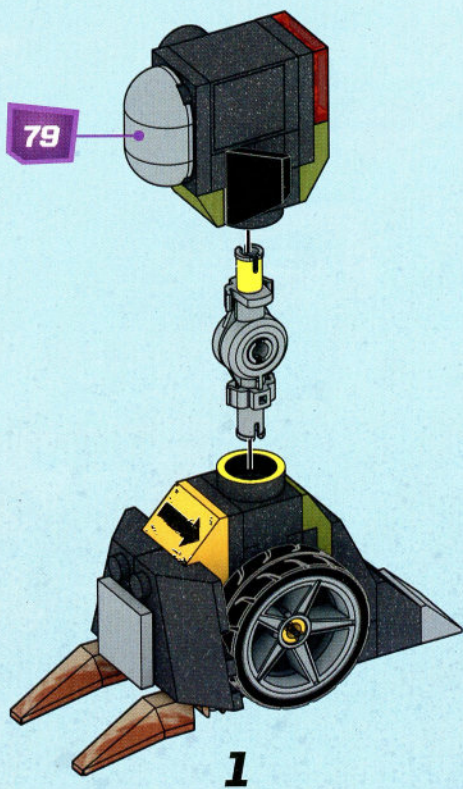

1

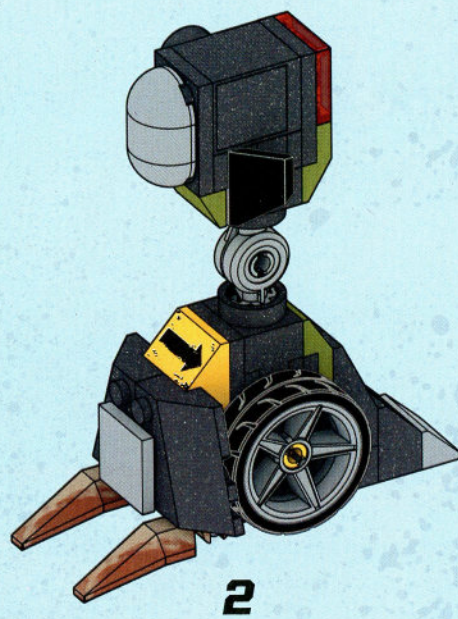

2

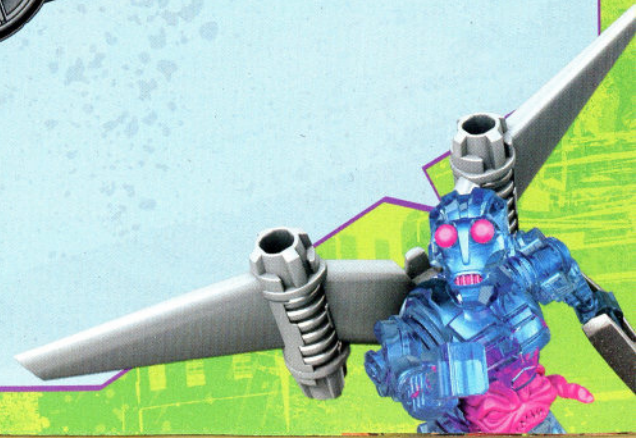

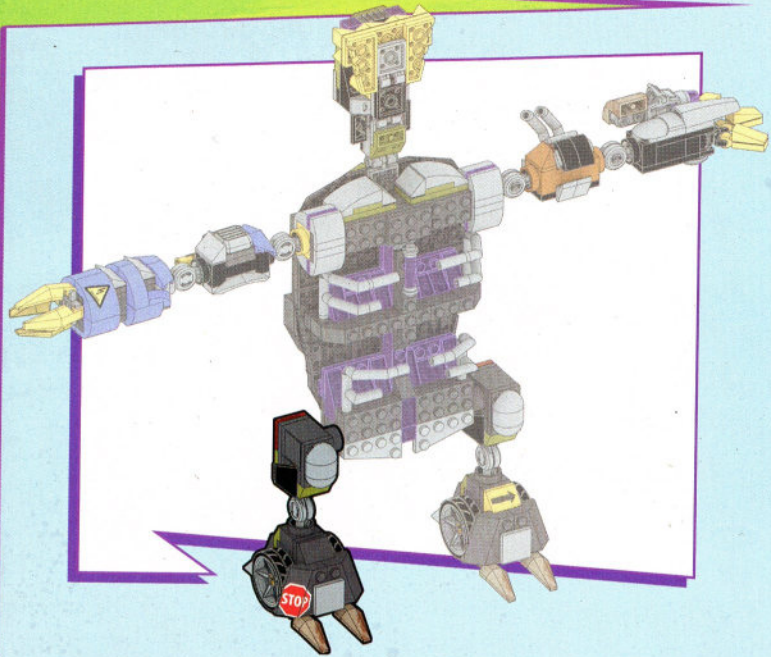

89

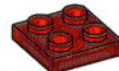

1x



1x



1x

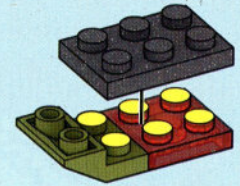

90



2x



1x

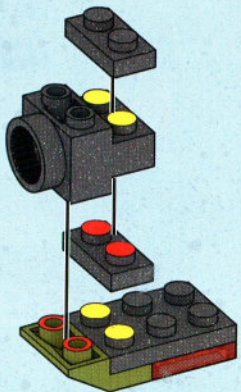

91



1x



1x

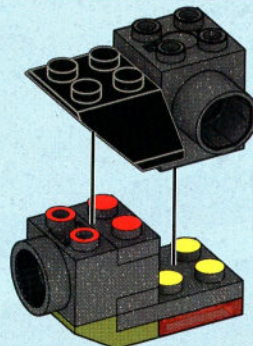

92



1x



1x



1x

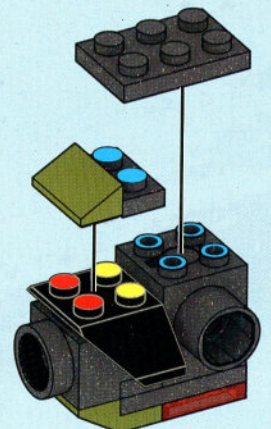
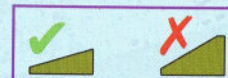

93



1x



2x

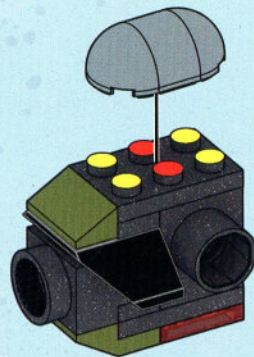

1

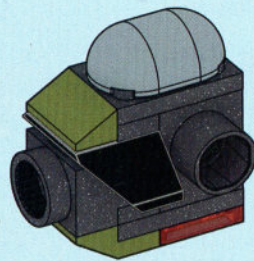

2

94



1x



1x



1x

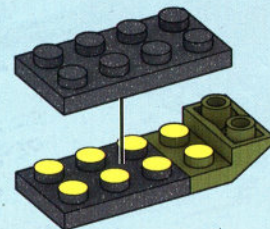

95



1x



1x

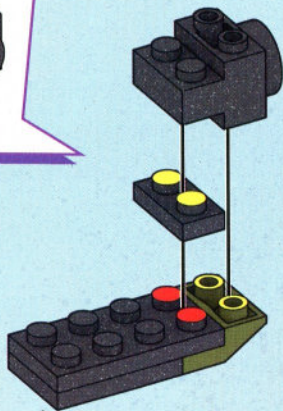

96



1x



2x



1x

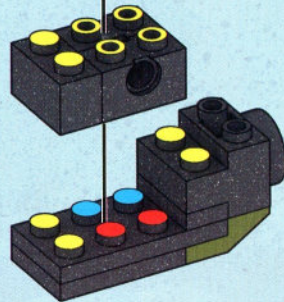

97



2x



1x



1x



1x



1x



1x



1x

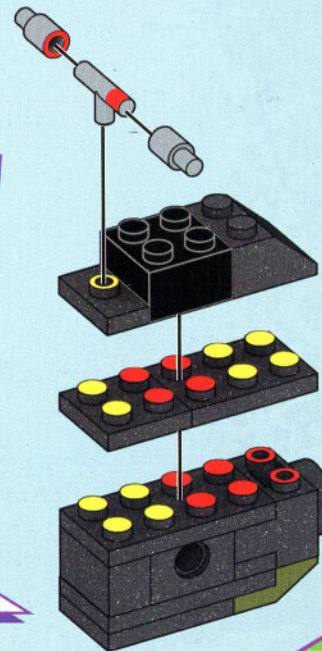

98

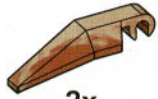

2x

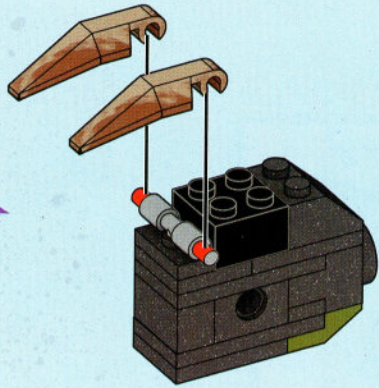

99

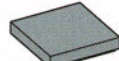

1x



1x



1x

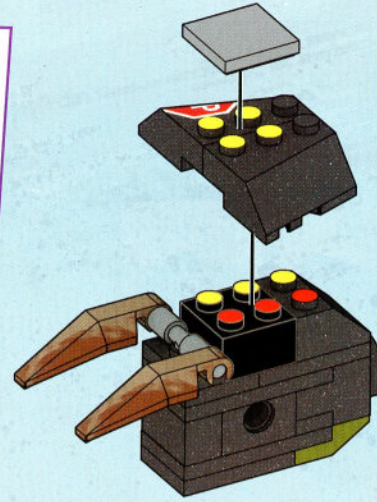

1

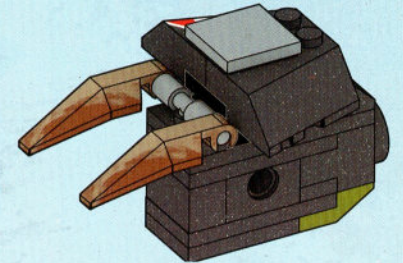

2

100



1x



1x



1x



1x

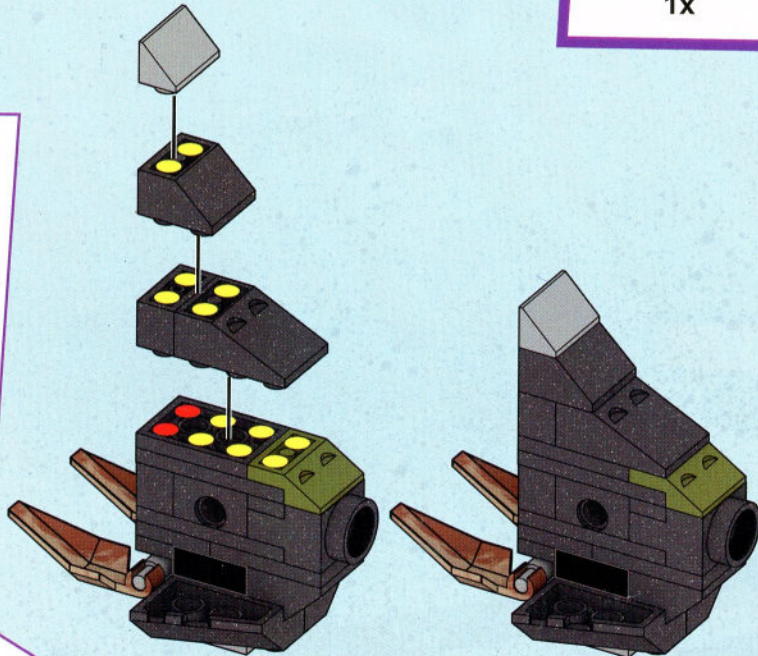

1

2

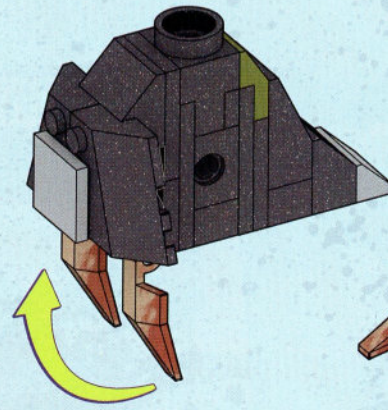

3

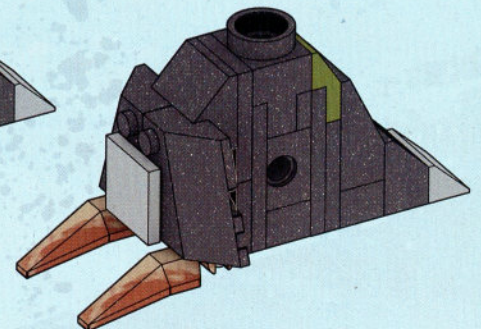

4

101



2x



1x



1x

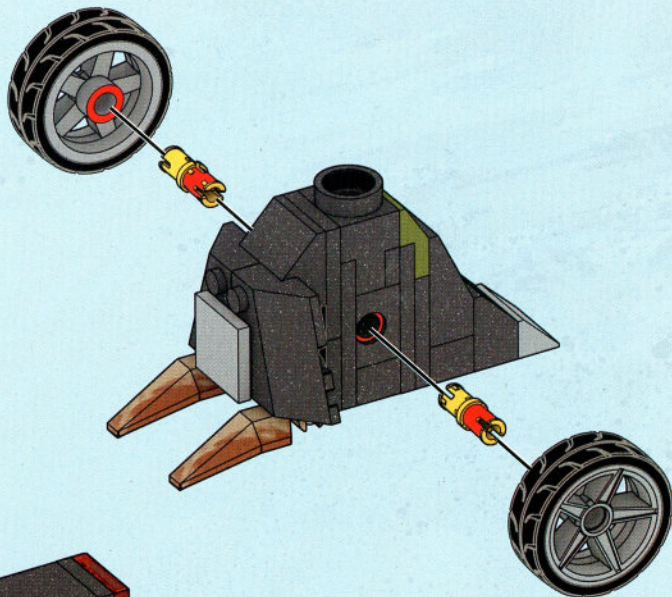

102



1x

93

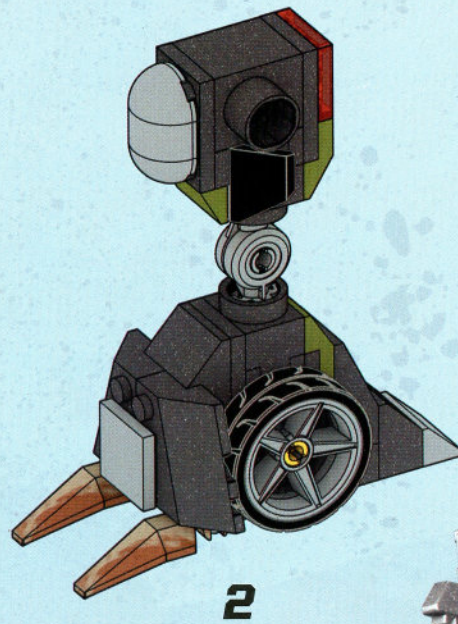
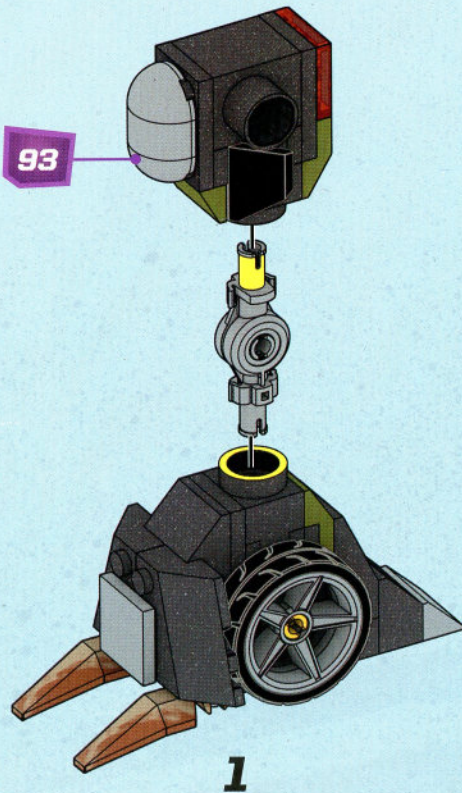

103

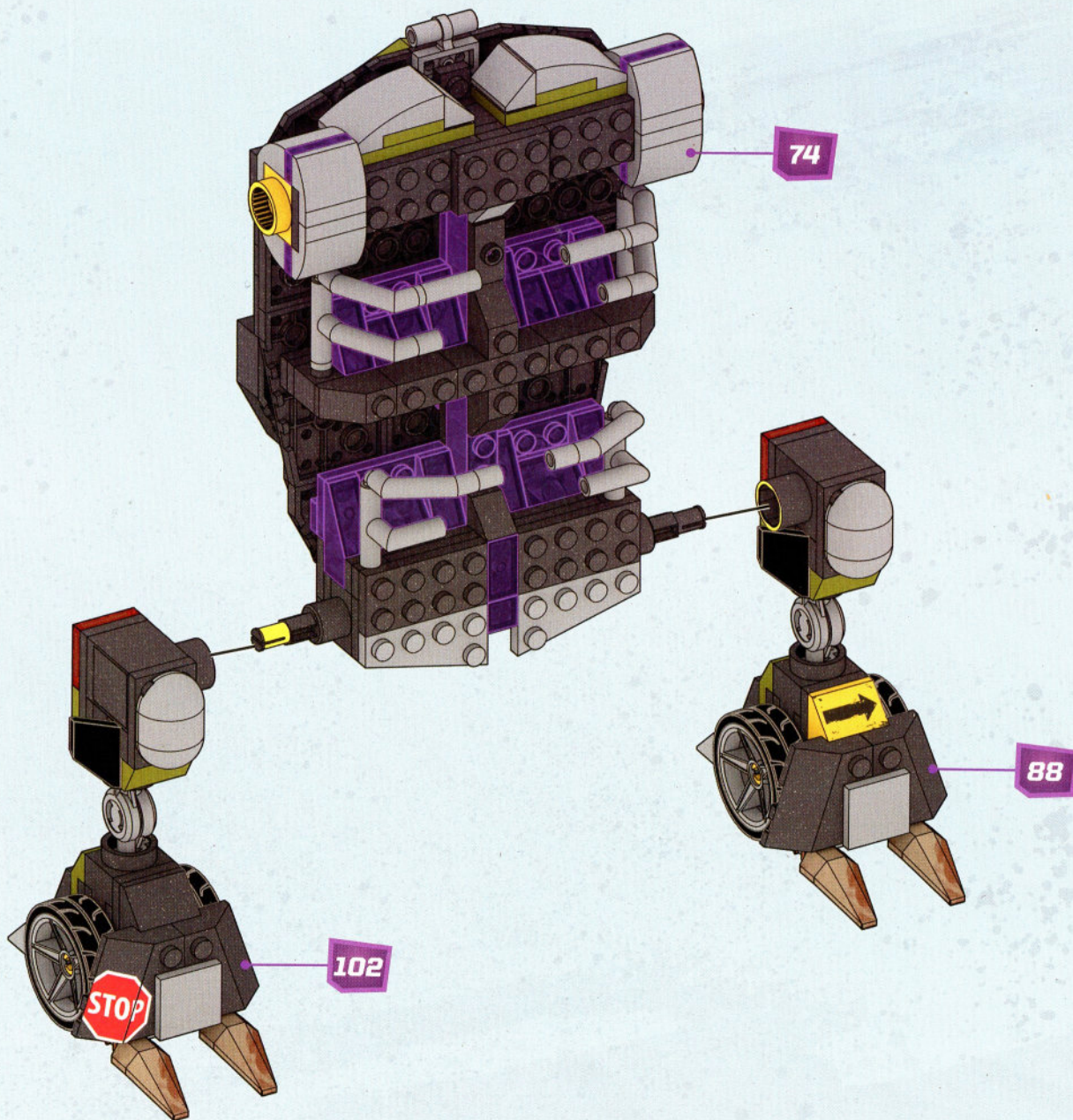

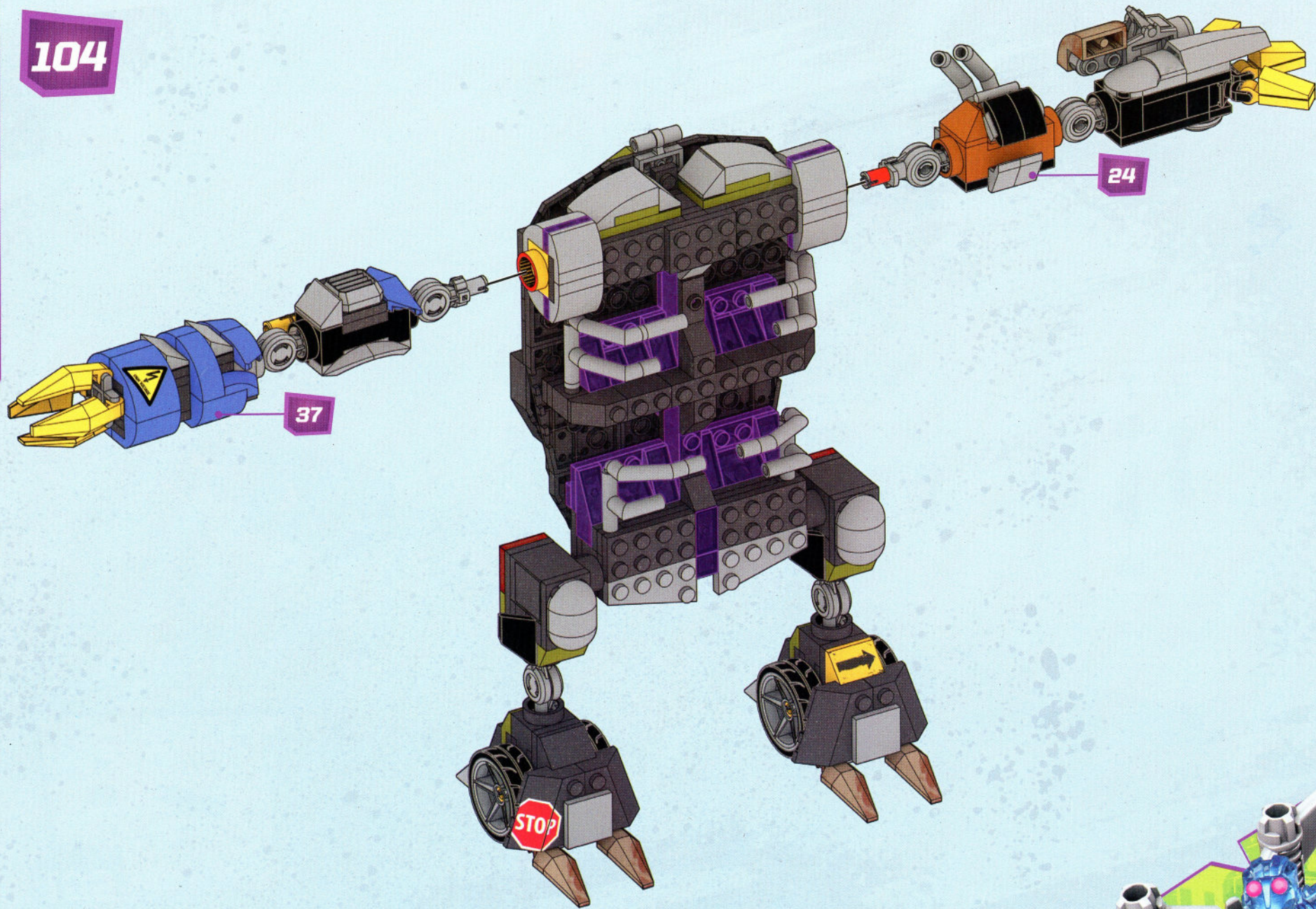

37

24



105



2x



1x

10

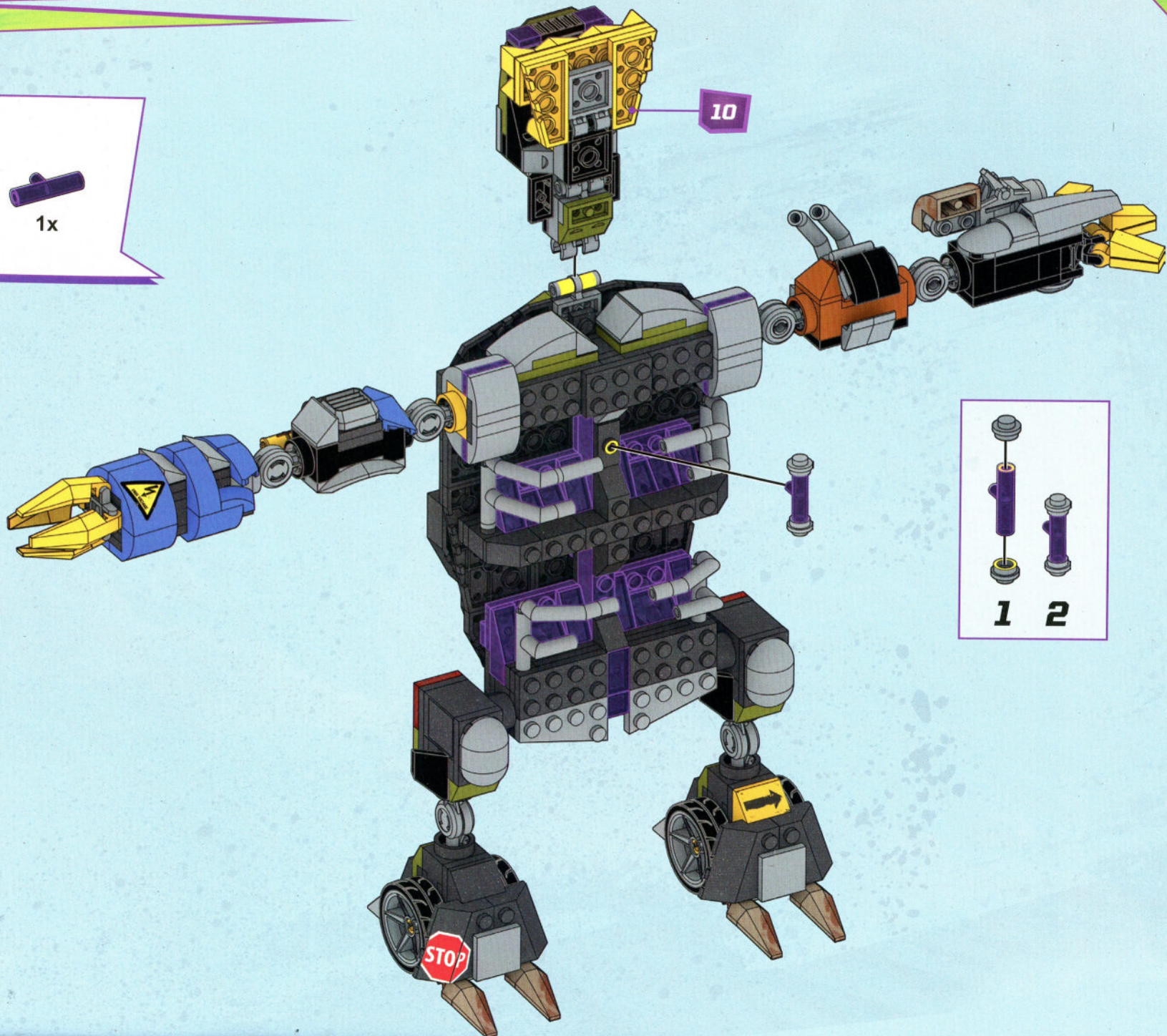

1



2



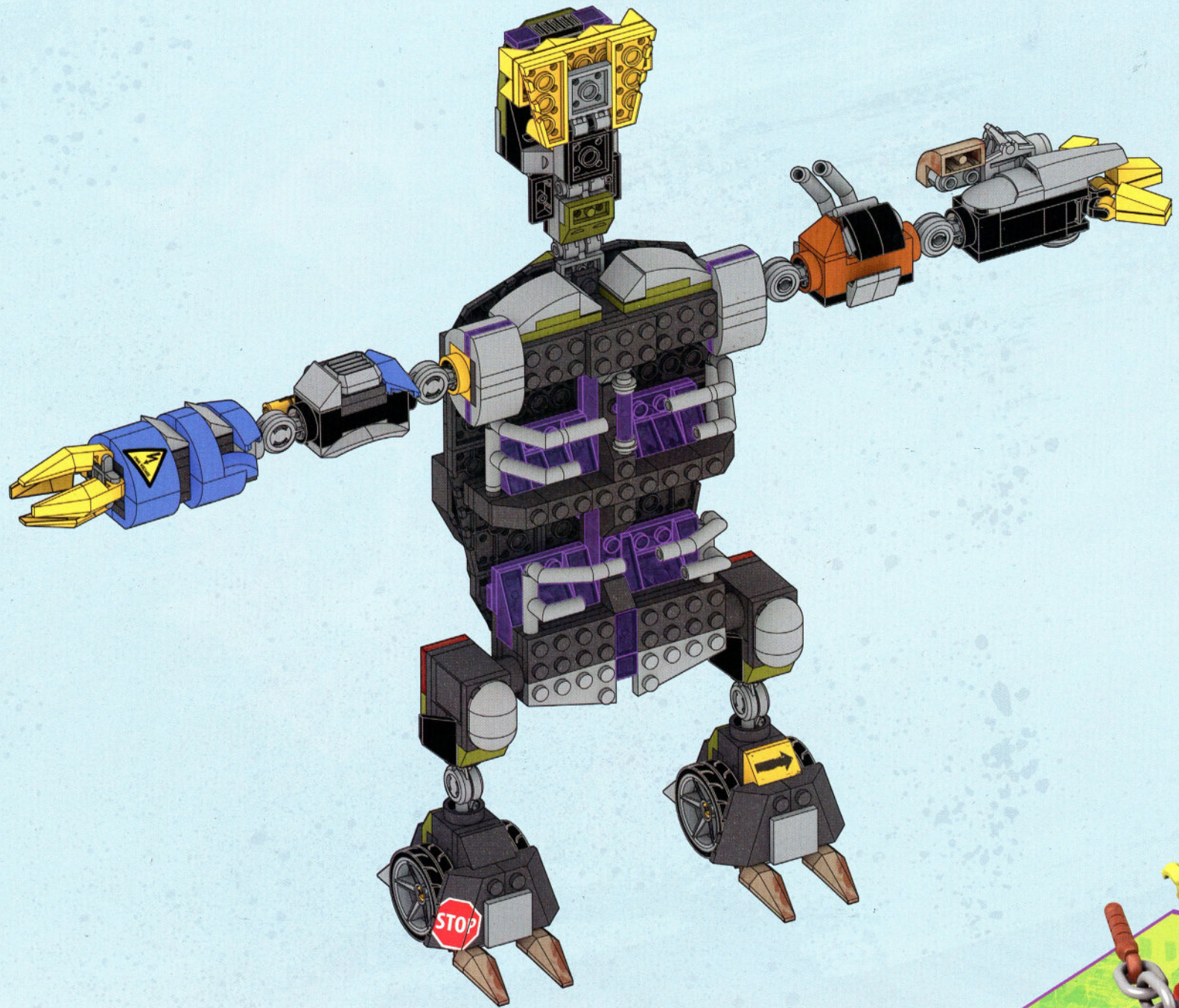





1

2

3

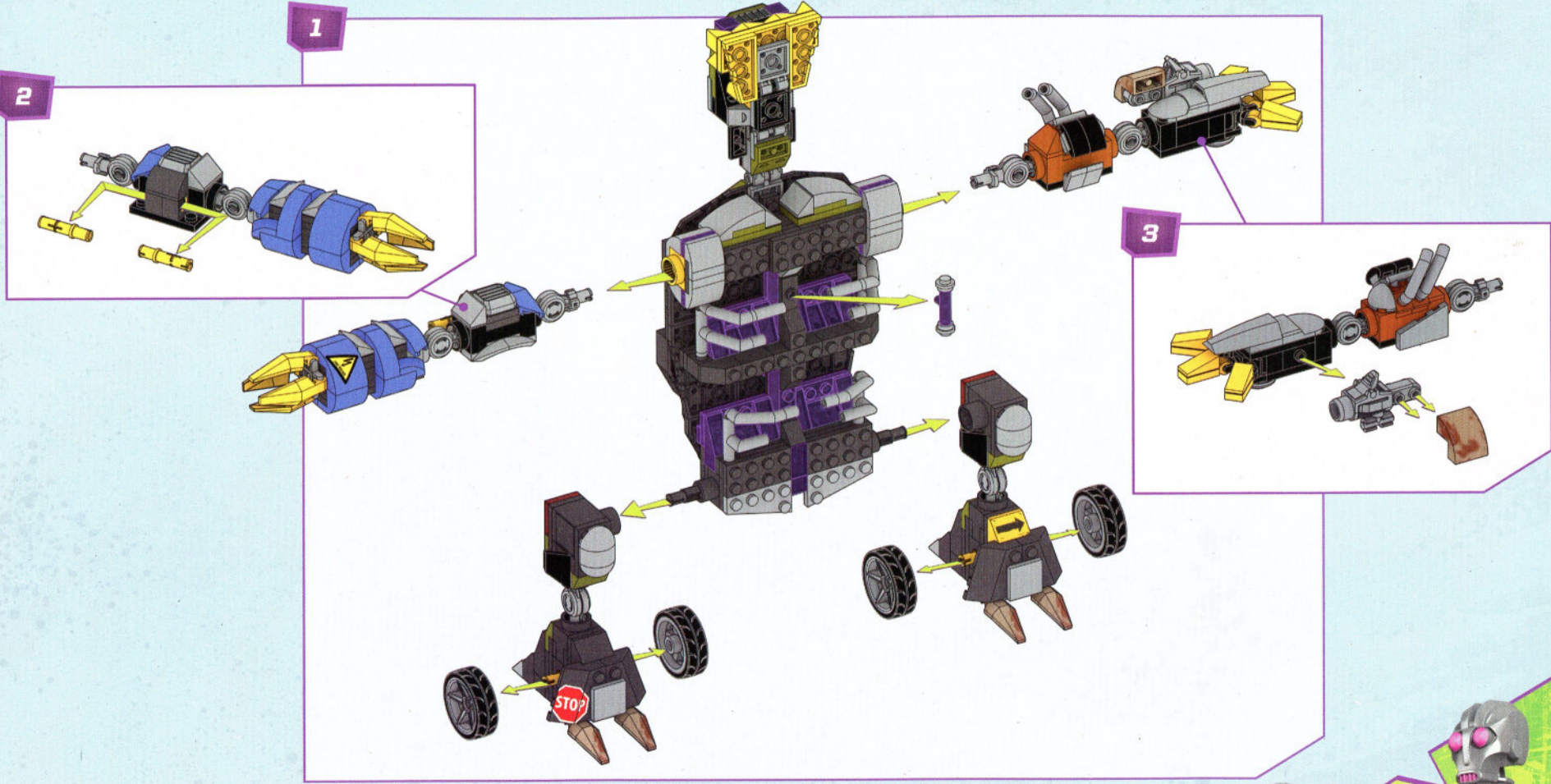

4

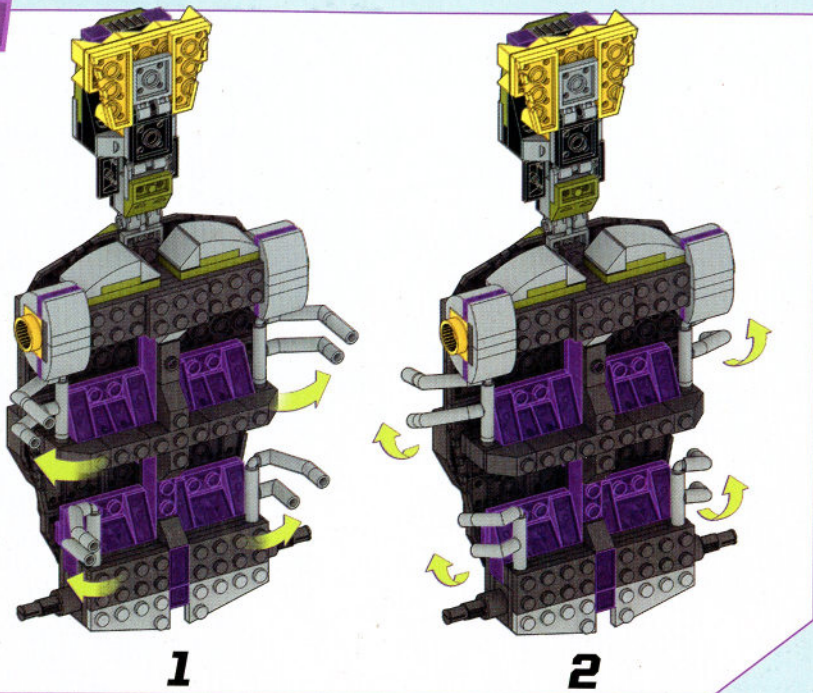

5

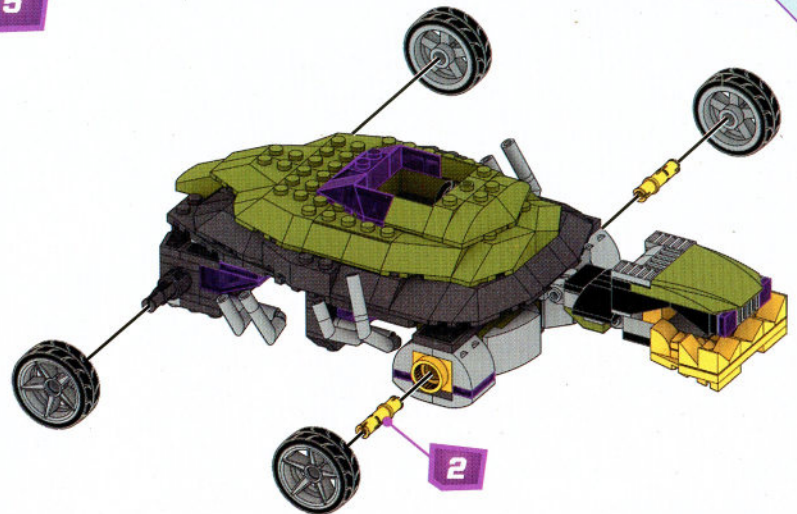

6

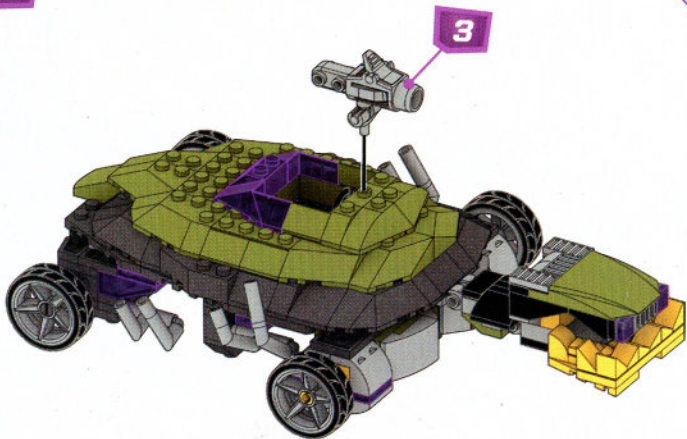

7

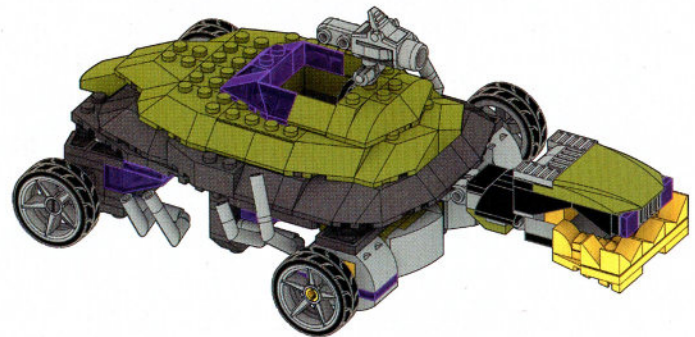



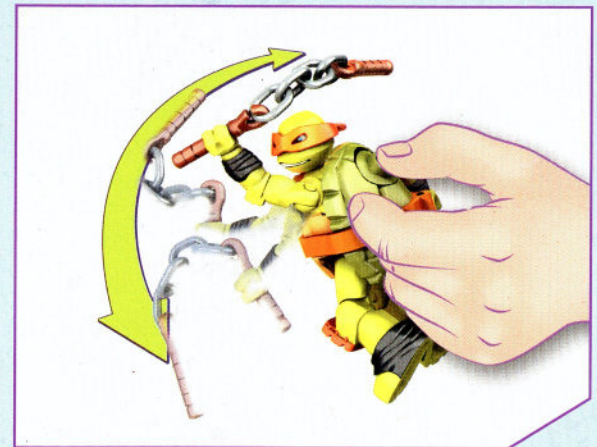
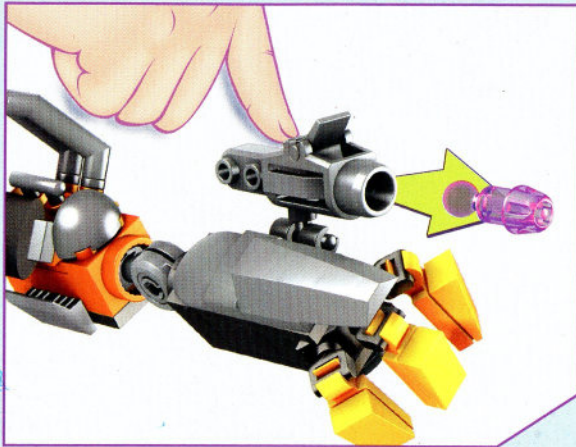
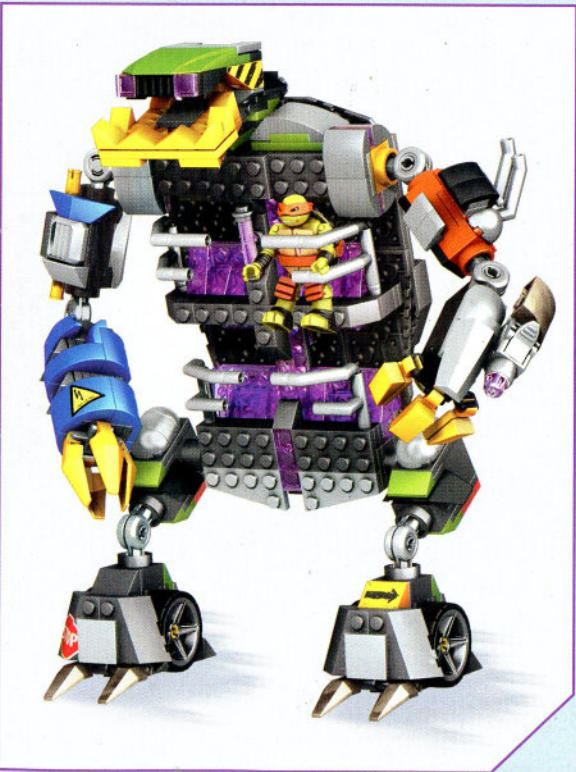
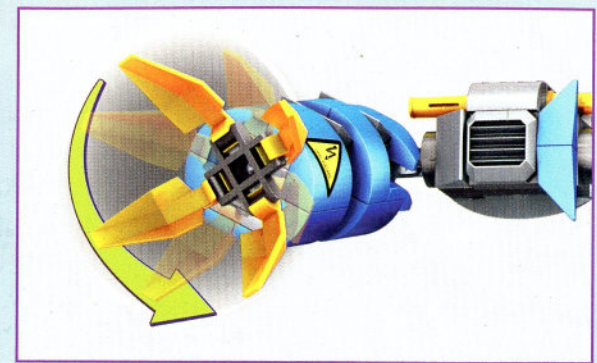
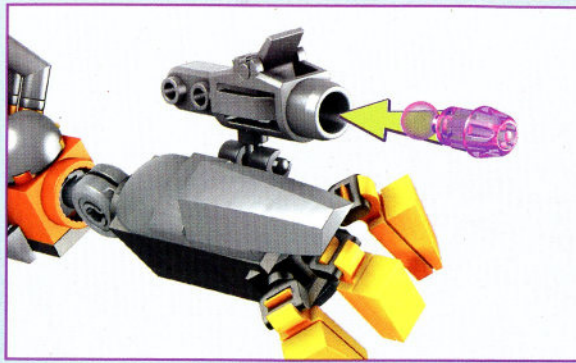
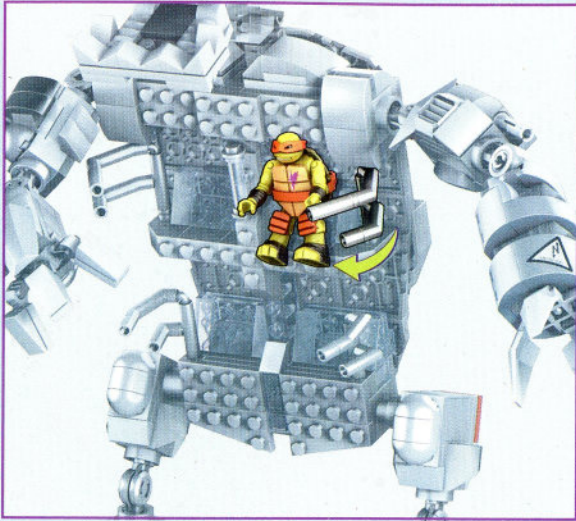

Warning: Do not aim at eyes or face. Only use projectiles supplied with this toy. Do not fire at point blank range.

Attention : Ne pas viser les yeux ou le visage. Ne pas utiliser d'autres projectiles que ceux fournis avec ce jouet. Ne pas tirer à bout portant.

Advertencia: No apuntar hacia los ojos o la cara. Utilizar exclusivamente los proyectiles suministrados con este juguete. No disparar a quemarropa.

Atenção! Não apontar para os olhos e para a face. Não utilizar projéteis diferentes dos providos. Não disparar excessivamente perto do alvo.

Attenzione: Non puntare agli occhi o al viso. Usa solo i proiettili forniti con il giocattolo. Non sparare a distanza ravvicinata.

Achtung: Nicht auf Augen oder Gesicht zielen. Nur die zu diesem Spielzeug gehörenden Projektile verwenden. Nicht auf Menschen oder Tiere oder aus nächster Nähe zielen.

Ostrzeżenie: Nie celuj w oczy ani w twarz. Używaj wyłącznie rzutek BOOMco.™. Nie strzelaj z bliska.

Waarschuwing: niet op ogen of gezicht richten. Gebruik uitsluitend de bijgeleverde projectielen. Niet van te dichtbij afschieten.

Предупреждение: Не направляйте в глаза или лицо. Используйте только детали, входящие в комплект. Не стреляйте со слишком близкого расстояния.

Advarsel: Sigt ikke mod øjne eller ansigt. Brug kun de projektiler, som følger med legetøjet. Skyd ikke direkte på personer eller ting.

Varning! Sikta inte mot ögon eller ansikte. Använd endast projektiler som medföljer leksaken. Fyra inte av på mycket nära håll.

Advarsel: Du må ikke sikte mot øyne eller ansikt. Bruk bare prosjektilene som følger med leken. Ikke skyt på noe på kloss hold.

Varoitus: Älä tähtää silmiin aläkä kasvoihin. Käytä ainoastaan tämän tuotteen mukana tulleita ammuksia. Älä ammu lähietäisyydeltä.

Προσοχή: Μην στοχεύετε στα μάτια ή στο πρόσωπο. Χρησιμοποιείτε μόνο τα βλήματα που περιλαμβάνονται. Μην στοχεύετε προς ανθρώπους ή ζώα.

تحذير: يجب عدم التصويب باتجاه العينين أو الوجه. يجب استخدام المقذوفات المزودة مع هذه اللعبة فقط. يجب عدم الإطلاق من مدى قريب.

警告: 请勿对着眼睛或脸部发射。仅使用本玩具自带的抛射物。请勿近距离射击。

警告: 目や顔を狙わないでください。このおもちゃに同梱されている発射物のみ使用するようになしてください。到達可能な距離内で火を燃やさないでください。

**TURTLE POWER | PODER DE TORTUGA NINJA  
 PODER DAS TARTARUGAS NINJA | МОЦ ŻÓЉВИ  
 ЧЕРЕПАШЬЯ СИЛА**



**SWIPING ACTION!  
 ACTION LATÉRALE!  
 ¡ACCIÓN DESLIZANTE! | GOLPE!  
 ATTACCA LATERALMENTE!  
 COOLE ANGRIFFSACTION!  
 WYPROWADZA ATAK!  
 AANVALLEN!  
 КУЛАЧНЫЙ БОЙ!**



DPF64



**ZIPLINE ACTION!  
 ACTION SUR FILIN!  
 ¡ACCIÓN DE CUERDA DE ESCAPE!  
 ANDA DE SLIDE!  
 AZIONE ECCLET!  
 SEIL-AKTION! | TYROLKA!  
 ZIPLIJNACTIE! | СКОРОСТНОЙ СПУСК!**



**SLASHING ACTION! | ACTION  
 DE FRAPPE! | ¡ACCIÓN DE ATAQUE!  
 MOVIMIENTOS DE BRAÇOS!  
 AZIONE DEVASTANTE!  
 SCHLAG-ACTION! | CIĘCIE! | WAT  
 EEN ACTIE! | ФУНКЦИЯ УДАРОВ!**

DMX52



**DOUBLE SLASHING ACTION!  
 ACTION DOUBLE FRAPPE!  
 ¡ACCIÓN DE DOBLE ATAQUE!  
 DUPLO ATAQUE!  
 DOPPIA AZIONE DEVASTANTE!  
 DOPPELTE SCHLAG-ACTION!  
 PODWÓJNE CIĘCIE!  
 DUBBELE ACTIE!  
 ДВОЙНЫЕ УДАРЫ!**



DMX51  
 DMX55



DMX54

VISIT | VISITE | VISITA | VISITA | VAI SU | AUF | WIĘCEJ | GA NAAR | ПОСЕТИТЕ ВЕБСАЙТ  
**TMNT.MEGABLOKS.COM**

FOR MORE TURTLES ACTION! | POUR ENCORE PLUS D'ACTION TORTUES NINJA!  
 PARA MÁS ACCIÓN DE TORTUGAS NINJA! | PARA MAIS AÇÃO COM AS TARTARUGAS NINJA!  
 E SCOPRI TUTTA L'AZIONE DEI NINJA TURTLES! | FINDET MÅN NOCH MEHR TURTLES-ACTION!  
 PRZYGDÓ Z ŻŁĘWIAMI NA | VOOR MEER NINJA TURTLES ACTIE! | ЧТО МОЖНО НАЙТИ  
 ДРУГИЕ ИГРЫ С ЧЕРЕПАШКАМИ!



© 2015, MEGA Brands Inc. ® & ™ MEGA Brands Inc. Printed in Canada. D-DPF66-05  
 © 2015 Viacom Overseas Holdings C.V. All Rights Reserved. Teenage Mutant Ninja Turtles and all related titles, logos and characters are trademarks of Viacom Overseas Holdings C.V.  
 Each sold separately and subject to availability. / Tous vendus séparément. Certains produits peuvent ne pas être commercialisés. / Se venden por separado y están sujetos a disponibilidad. / Vendidos em separado e sujeitos a disponibilidade. / Ognuno in vendita separatamente secondo disponibilità. / Alle Artikel separat erhältlich. Einige Artikel werden nicht in allen Ländern vertrieben. / Sprzedawane oddzielnie w zależności od dostępności. / Per stuk verkrijgbaar en niet overal leverbaar. / Каждый продукт продается отдельно, в зависимости от наличия. / Sælges separat og så længe lager haves. / Alla delar säljs separat.  
 تباع كل منها على حدة وتخضع لتوفرها. 每件单独出售，并且视库存情况而定。 それぞれ在庫状況に従って個別に販売されます。