

TEENAGE MUTANT NINJA TURTLES

TURTLE TACTICAL TRUCK

ASSEMBLY:

I. Parts:

Assemble loading forks and attach as shown.

FRONT

Attach net launcher and rear bumper as shown.

BACK

II. Stickers:

Attach stickers as shown.

BACK

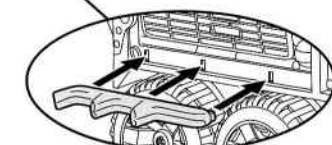
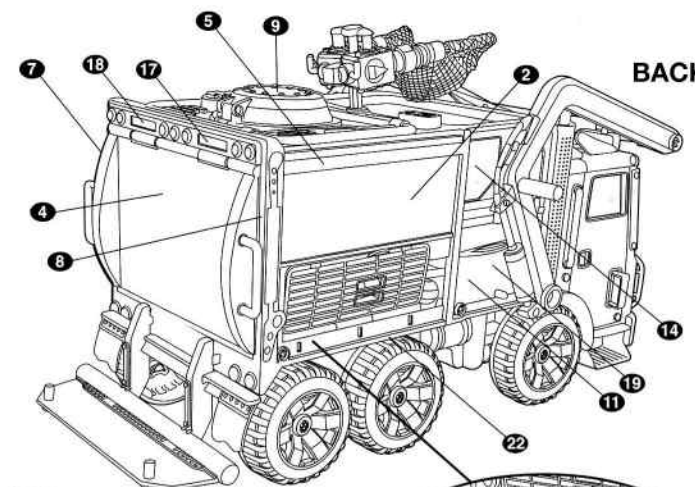
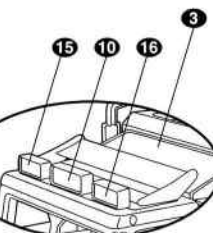

After all stickers are in place, attach exhaust pipes to both sides of the vehicle as shown.

FRONT

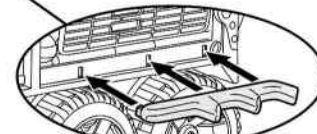

FEATURES:

Load both sides of the capture net as shown.

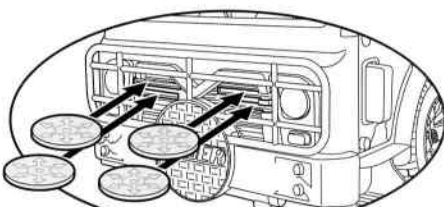
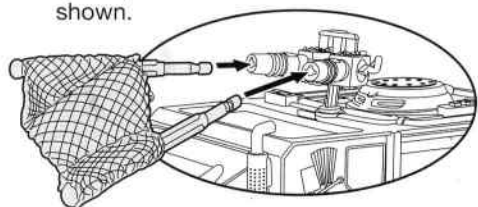

Load up to four ninja discs into the front of the vehicle as shown.

Press down on the switch to fire the net.

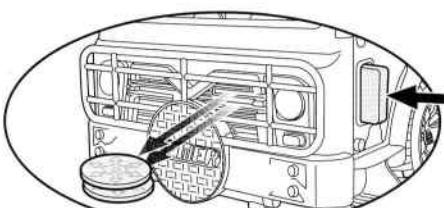
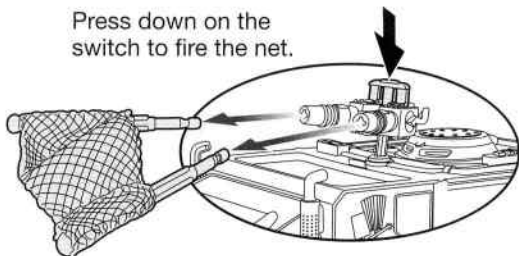

Fire two ninja discs at a time by pressing the button on the side of the vehicle.

Do not insert projectiles other than those provided with the toy.
Do not discharge in the direction of people or animals, especially at the eyes or face.

Figures can be loaded into the top or back of the vehicle, or ride on the loading forks or rear bumper.

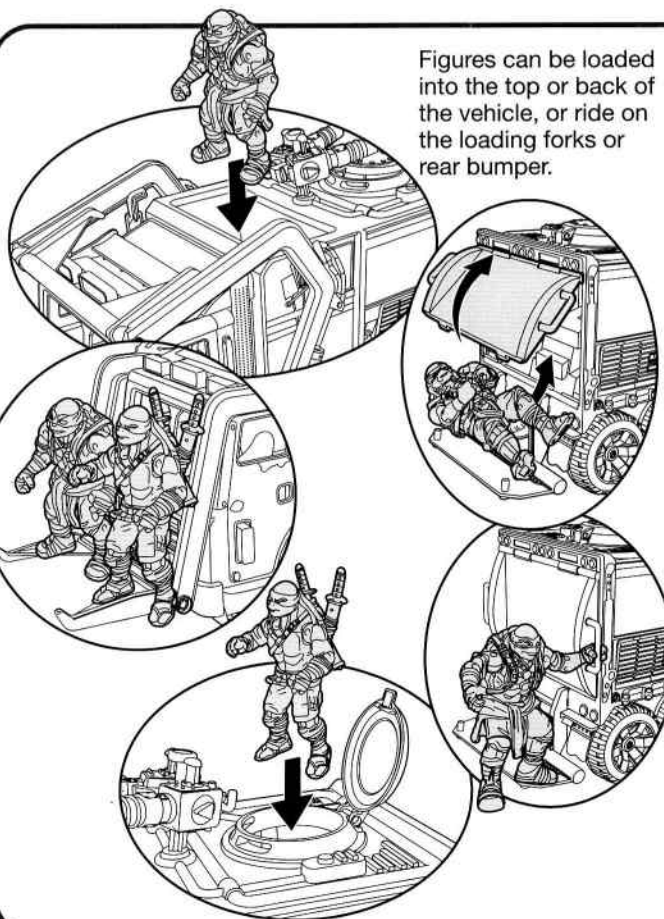

1. Raise Loading forks to open driving compartment.



2. Open driving compartment by swinging the top forward and down.



3. Position figures in the seats.



1. Access the giant nunchucks by opening the side doors.

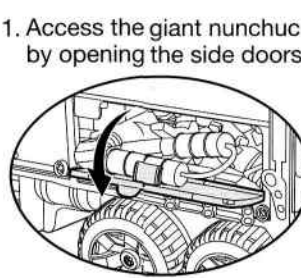

2. Unclip the nunchucks from the storage clip.

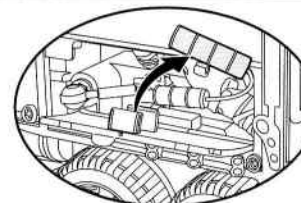

4. Nunchucks will spin as the vehicle rolls forward or back!

3. Pull arm out until it clicks into the extended position.

