

MEGA  
CONSTRUX™

nickelodeon

TEENAGE MUTANT NINJA  
TURTLES



FFC63

- 1x AM75332KC
- 2x AM18560APG
- 2x MA1113MM
- 9x M1113KC
- 3x M1113AQD
- 2x AM17062TS
- 2x MA74397TS
- 4x MA03328MM
- 2x AM77574MM
- 1x AM16980APG
- 3x MA18623TS
- 1x AM74299AJK
- 1x AM74300AJK
- 6x MA1086AKQ
- 2x MA07629AGQ
- 2x AM77017APG
- 2x AM77042APG

- 1x AM78518KC
- 1x AM76776AQD
- 1x AM18260AMC
- 14x AM74415TS
- 3x MA022501TS
- 1x MA09393AGQ
- 5x MA09393MM
- 1x AM08530TS
- 6x MA1322TC
- 8x MA09013AGQ
- 3x MA09013TC
- 49x MA09013AKQ
- 2x MA07658AGQ
- 1x AM76560AGQ

- 1x AM76559MM
- 12x MA1417AGQ
- 1x AM18628AMC
- 2x AM76820APG
- 12x MA03773MM
- 1x AS-FFC63-04
- 1x AM16968TS
- 2x AM19329TS
- 2x MA18329TS
- 1x AM77464TC
- 2x AM16967MM
- 7x MA09023AGQ
- 8x MA09023TC

- 4x MA18671TC
- 6x MA1087AGQ
- 1x MA03772TC
- 1x AM17408TC
- 2x MA09493TC
- 1x AM19998TC
- 1x AM19997TC
- 1x AM78637APG
- 1x AM78638AJK
- 2x AM78898KC
- 1x AM78517XT

- 1x AM15064MT
- 1x AM18593APG
- 7x AM17147MM
- 3x MA04497MM
- 2x MA16959AJK
- 3x AS-FFC63-05
- 2x AM78681AJK
- 1x AM76953AJK
- 4x MA07475MM
- 7x MA09292MM

- 2x AM02920AJK
- 1x AM18292TC
- 1x AM77193TC
- 3x MA1480MM
- 1x AS-FFC63-06
- 1x AS-FFC63-01
- 1x AS-FFC63-03
- 5x MA18298MM
- 2x MA08483MM
- 1x AS-FFC63-02



1x  
AM73222AQD

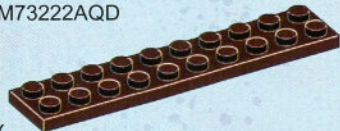

3x  
MA09923DH

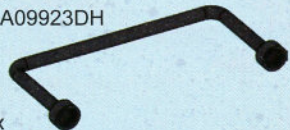

1x  
AM01462MM

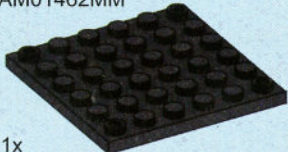

1x  
MA74681MM



1x  
AM76951MM

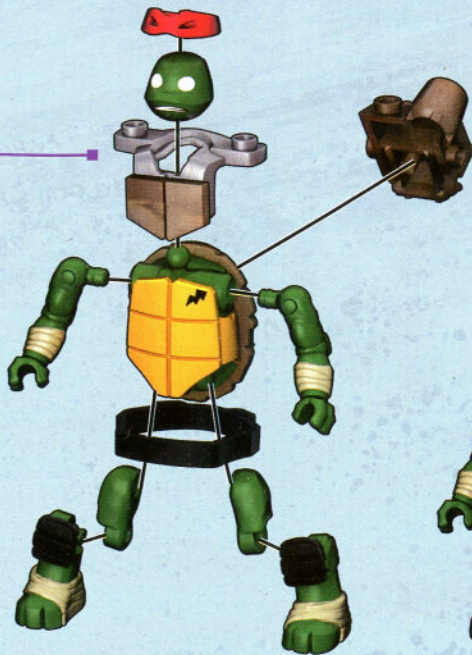
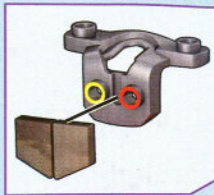
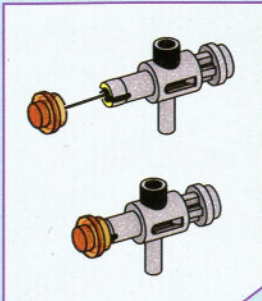

1x  
FIG-FFC63-A



- ⚠ WARNING:  
CHOKING HAZARD. - Small parts.  
Not for children under 3 years.
- ⚠ ATTENTION:  
DANGER D'ÉTOUFFEMENT. - Présence de petits éléments.  
Ne convient pas aux enfants de moins de 3 ans.
- ⚠ 警告:  
噎住危險。包含有小部件  
不适合3岁以下的小孩玩。
- ⚠ 警告:  
のどにつまる危険。小さな部品が含まれています  
3歳以下の子供には与えないで下さい。  
تحذير:  
خطر الاختناق - قطع صغيرة.  
غير صالحة للأطفال أقل من 3 سنوات.

ADVERTENCIA: Peligro de asfixia. Juguete no recomendado para menores de 3 años, porque contiene piezas pequeñas que podrían provocar asfixia en el caso de ser ingeridas o inhaladas por el/la niño/a.  
ATENÇÃO: Não recomendável para crianças com menos de 36 meses. Contém peças pequenas capazes de criar risco de asfixia.  
AVVERTENZA: Contiene pezzi di piccole dimensioni.  
ACHTUNG: Kleine Teile.  
OSTRZEŻENIE: Małe części  
WAARSCHUWING: Kleine onderdelen  
ПРЕДУПРЕЖДЕНИЕ: Мелкие детали  
ADVARSEL: Små dele.  
WARNING: Smådelar  
ADVARSEL: Små deler.  
VAROITUS: Pieniä osia  
ΠΡΟΣΟΧΗ: Περιλαμβάνονται μικρά κομμάτια.  
UYARI: BOĞULMA TEHLİKESİ - Küçük Parçalar İçerir. 3 yaşından küçük çocuklar için uygun değildir.



Please read these instructions carefully before first use and keep them for future reference.  
Il est recommandé de lire attentivement ce feuillet avant la première utilisation et de le conserver pour référence future.  
Leer estas instrucciones cuidadosamente antes de la primera utilización y guardarlas para referencia futura.  
Leia as instruções antes do primeiro uso e guarde-as para futura referência.  
Leggere le istruzioni prima di cominciare ad usare il gioco e conservarle per reference future.  
Die Gebrauchsanleitung bitte durchlesen und aufbewahren.

Proszę uważnie przeczytać instrukcję obsługi przed pierwszym użyciem, a następnie zachować ją na przyszłość.  
Wij raden u aan deze handleiding zorgvuldig te lezen en te bewaren voor eventuele raadpleging op een later tijdstip.  
Внимательно прочитайте инструкцию перед первым использованием и сохраните ее для дальнейшего использования.  
Vær venlig at læse disse instruktioner omhyggeligt inden ibrugtagen og opbevar dem til fremtidigt brug.  
Läs noggrant igenom dessa instruktioner innan du använder produkten för första gången och spara dem för ev. framtida frågor.  
Les disse instruksjonene nøye før første gangs bruk, og ta vare på dem for fremtidig oppslag.  
Lue nämä ohjeet huolellisesti ennen ensimmäistä käyttöä ja säilytä ne myöhempää tarvetta varten.  
Διαβάστε προσεκτικά τις οδηγίες πριν από τη χρήση και κρατήστε τις για μελλοντική αναφορά.  
İlk kullanımdan önce talimatları dikkatlice okumanızı ve bu bilgileri ileride tekrar bakabilmek için saklamanızı öneririz.  
第一次使用前，請仔細閱讀本說明書並保留以備將來參考。  
初めてご使用になる前に、この説明書をよくお読みください。また、本書は将来いつでも参照できるように保管してください。

يجب قراءة هذه التعليمات بعناية قبل الاستخدام والاحتفاظ بها للعودة إليها مستقبلاً.  
© 2016 Viacom Overseas Holdings C.V. All Rights Reserved. Teenage Mutant Ninja Turtles and all related titles, logos and characters are trademarks of Viacom Overseas Holdings C.V.



PLAY.MEGA CONSTRUX.COM

Patent pending.  
Brevet en instance.

Ⓟ D714,887

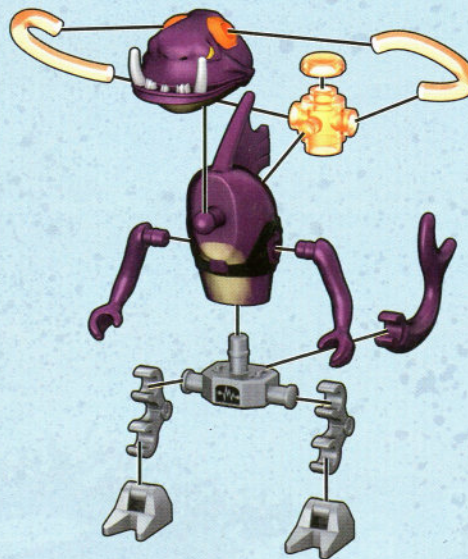

1x  
FIG-FFC63-B



**1**



1x

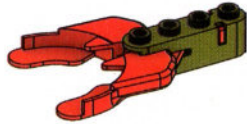

1x

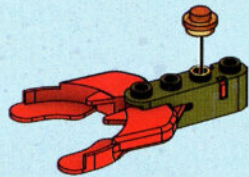

**1**

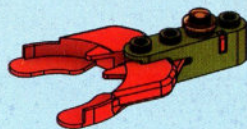

**2**

**2**



1x



1x

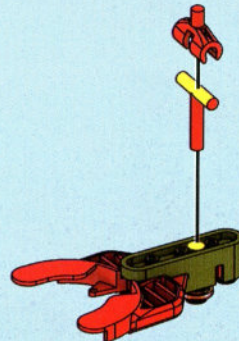

**1**

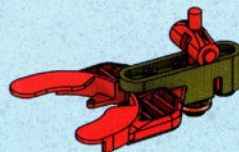

**2**

**3**



1x

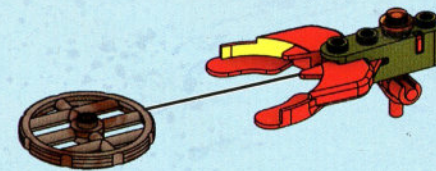

**1**

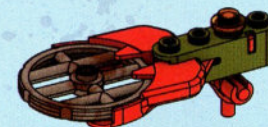

**2**

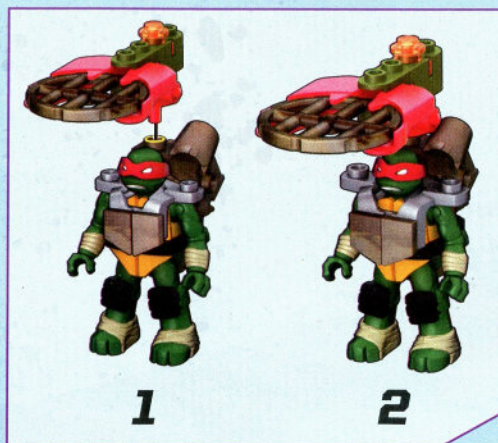

**1**

**2**

4



5



6

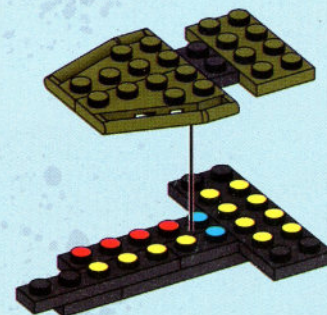
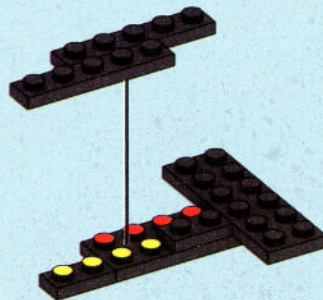
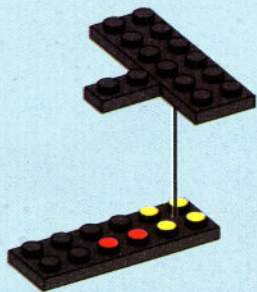
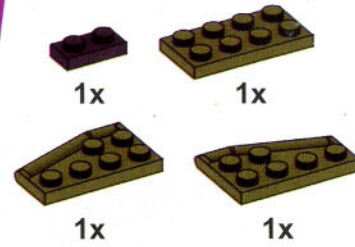

7



1x

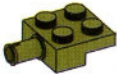

2x

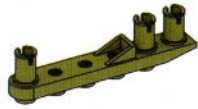

1x

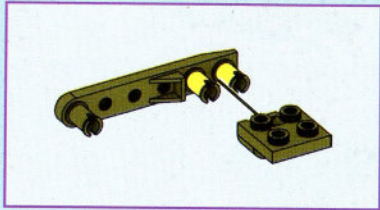

8



1x



1x

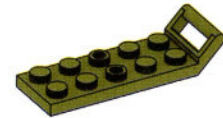

1x

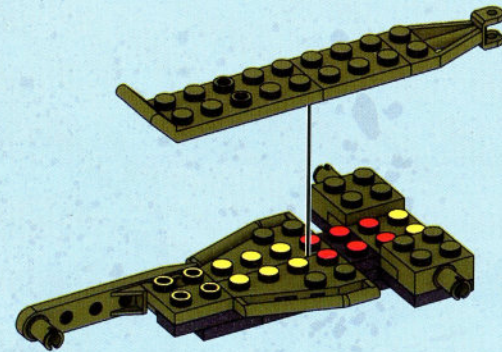
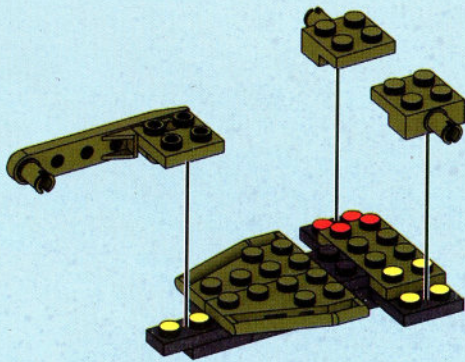

9



3x

10



2x

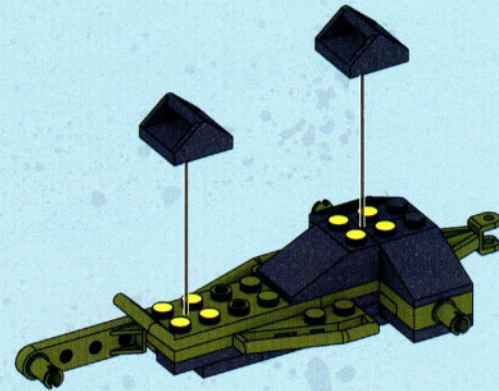
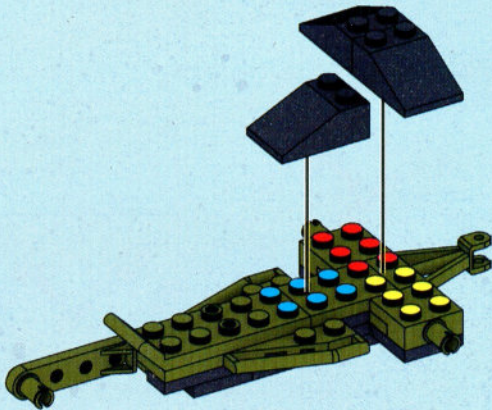

11

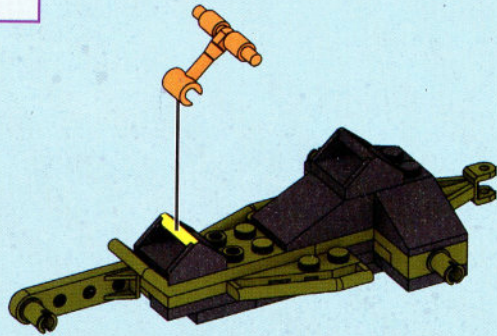
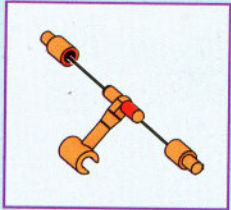
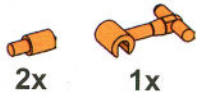

1

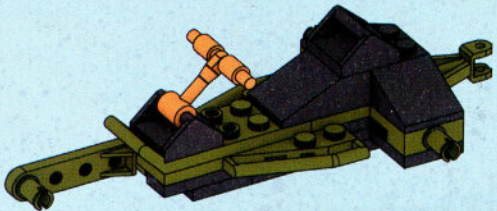

2

12

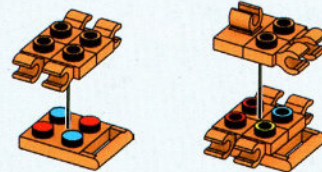
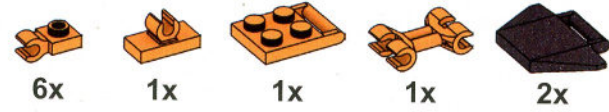

1

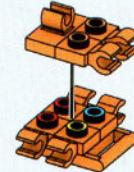

2

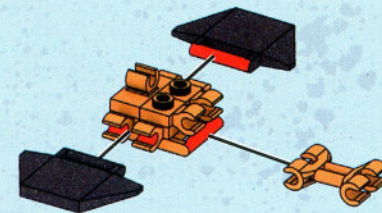



**13**



1x

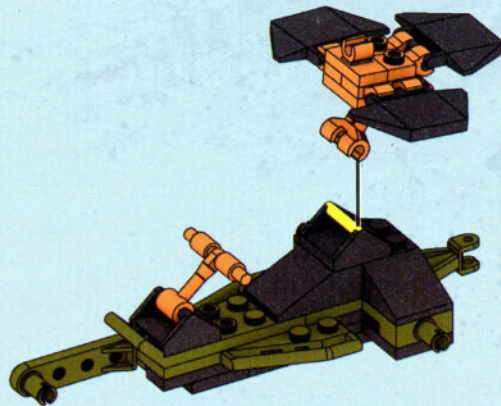
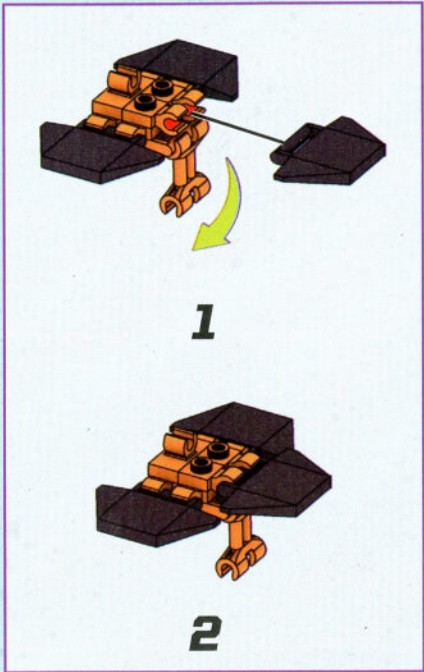

**1**

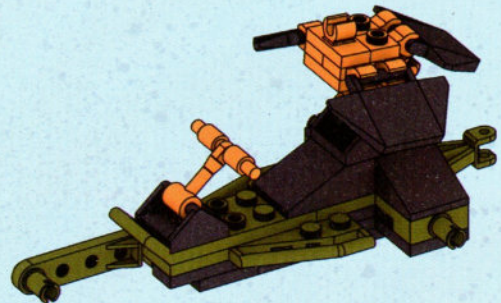

**2**



14



2x



8x



1x

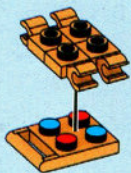

1

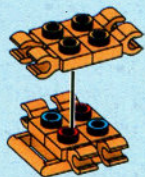

2

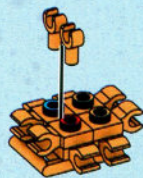

3

15



1x



3x

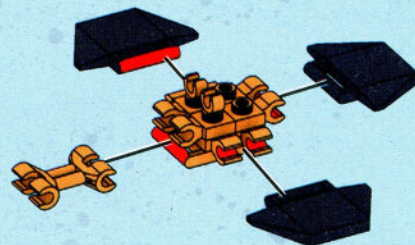

16



1x



2x

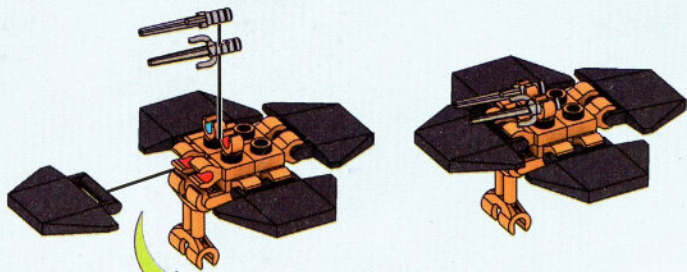

1

2

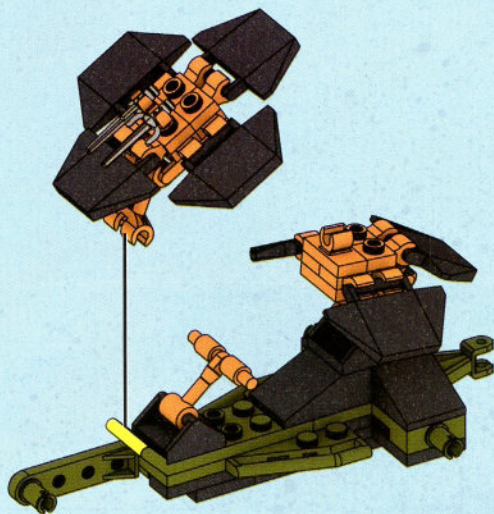

17



1x

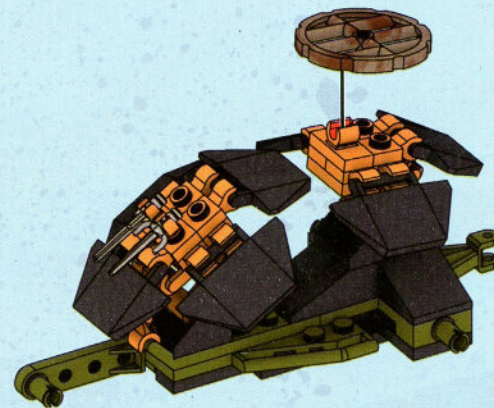

18



3x

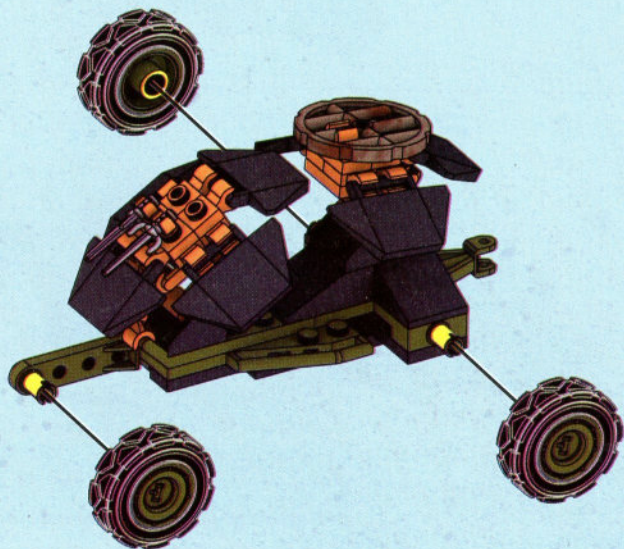

1

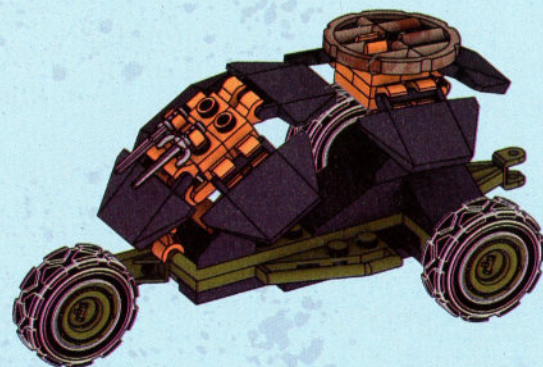

2

19



2x

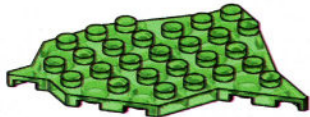

1x

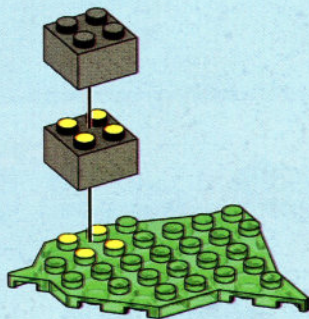

20



1x



1x



1x



2x

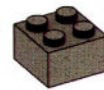

2x



1x

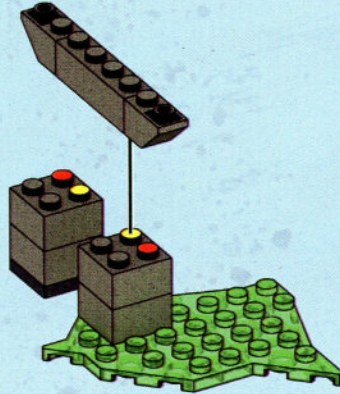
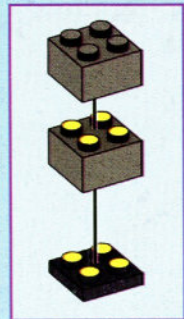

1

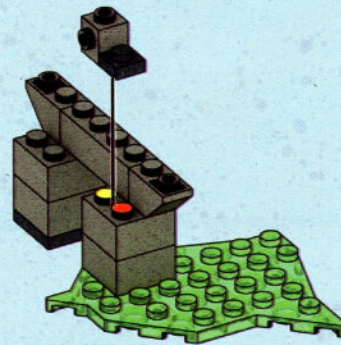

2

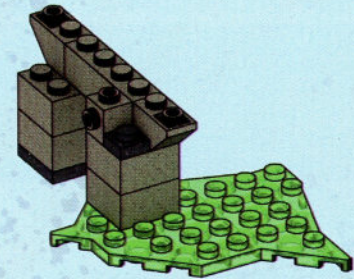

3



21

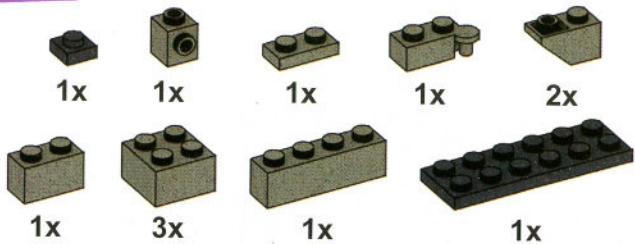

22

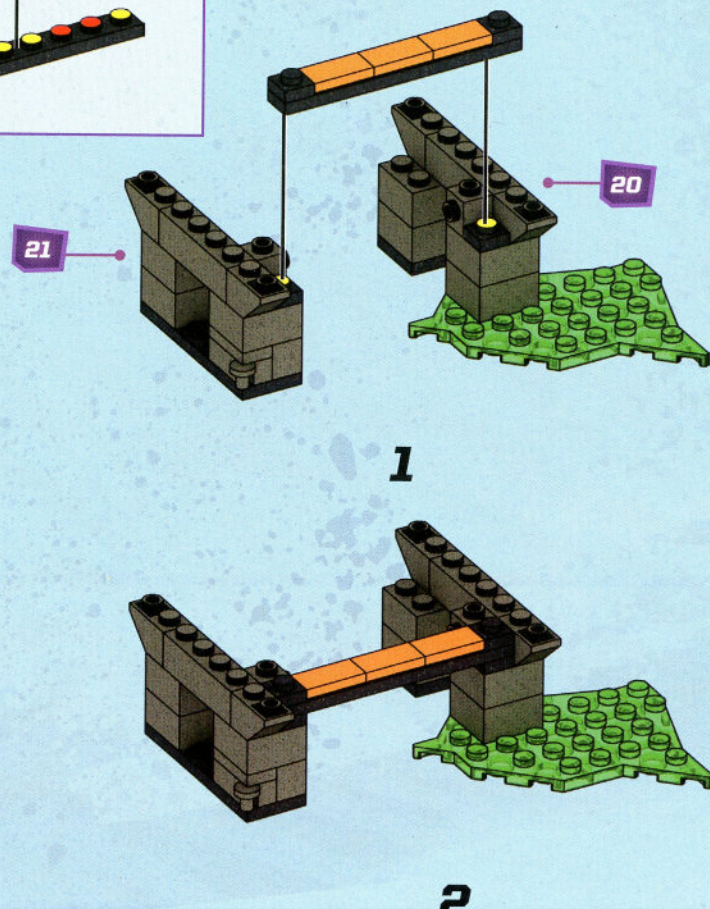
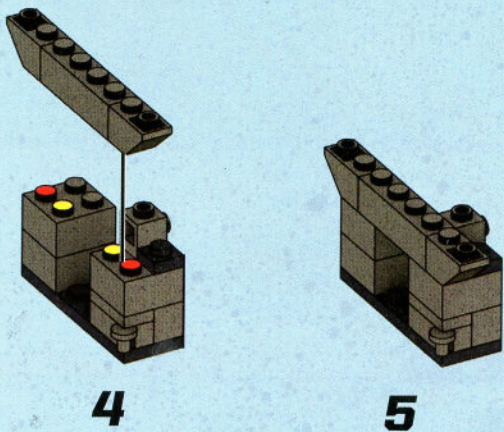
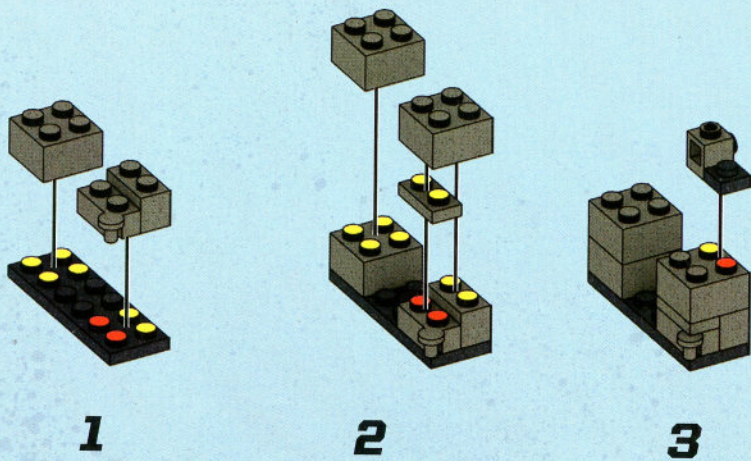
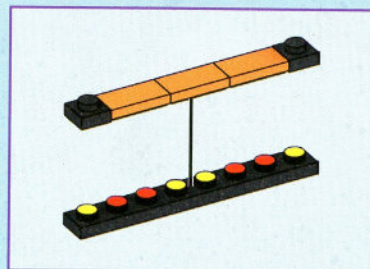
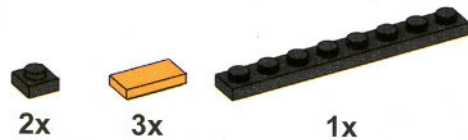

23

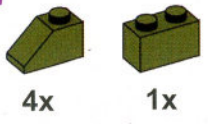

1x

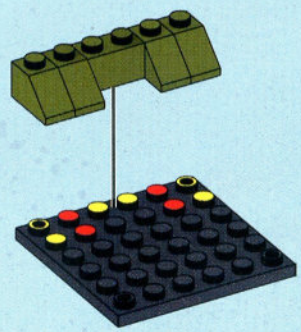

24

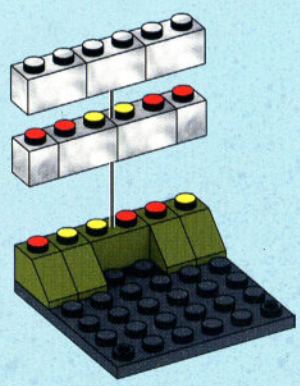
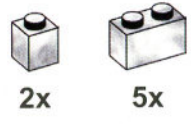

25

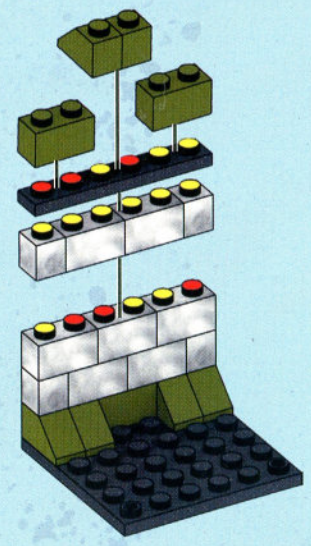
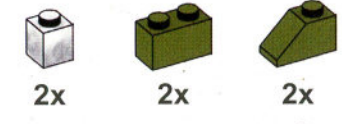

26

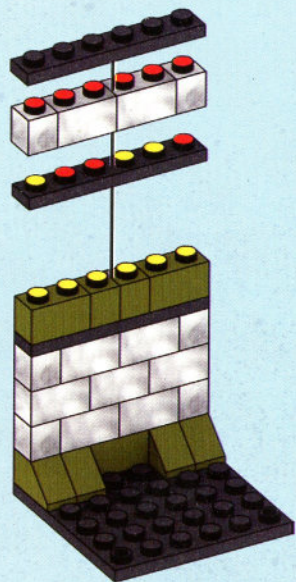
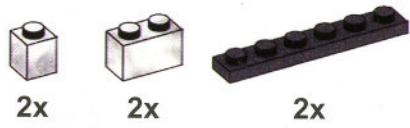

27

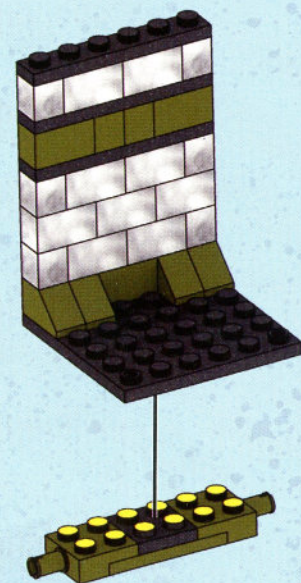
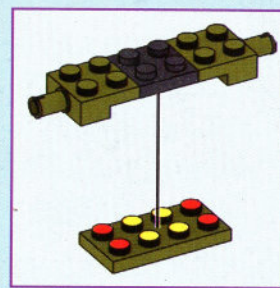
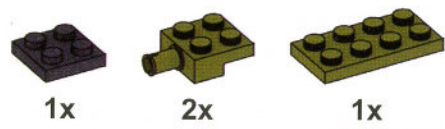



28



2x

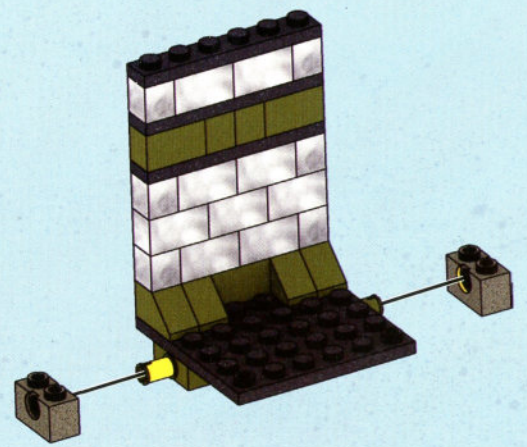

29

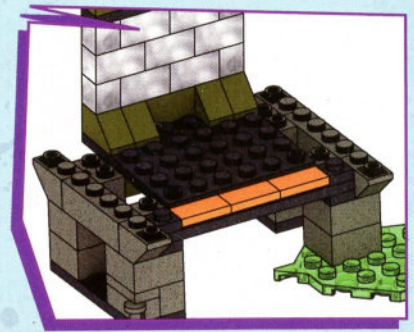
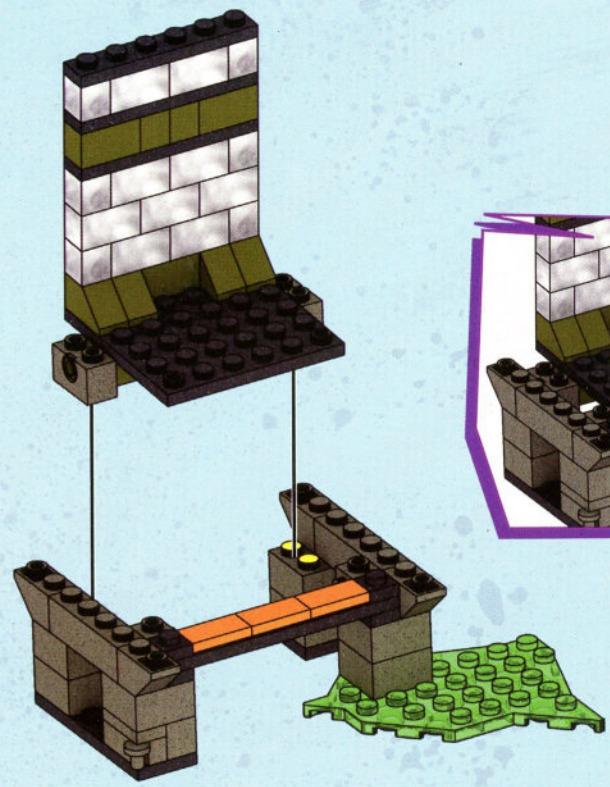

**30**



2x

**31**



2x



1x



1x



**1**



**2**

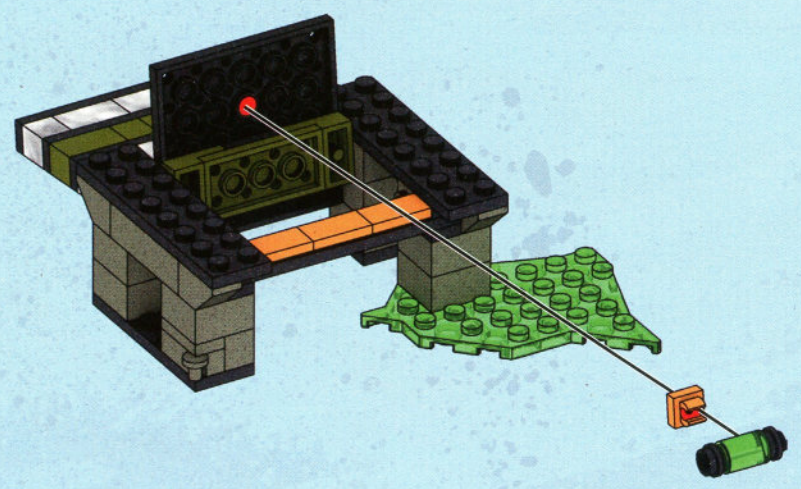
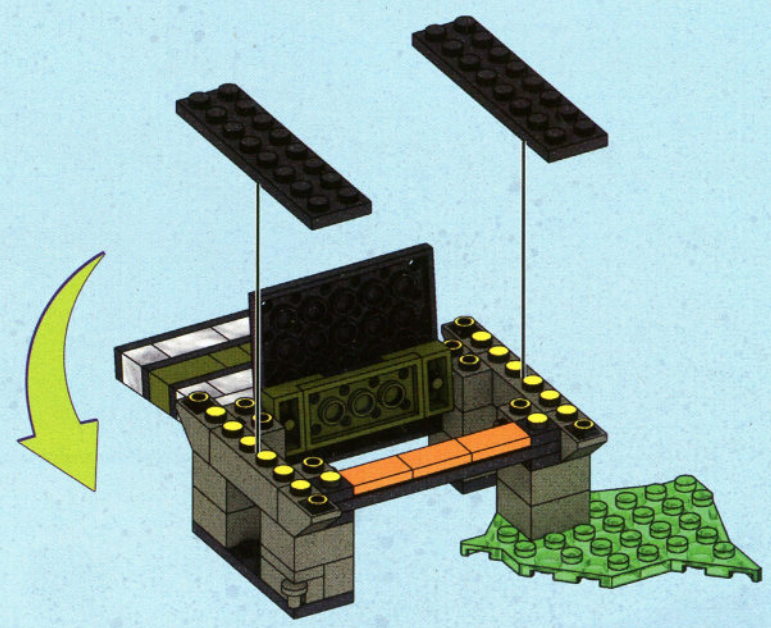

32



40x



8X



8x

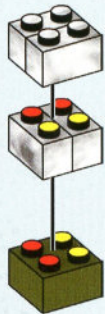

1

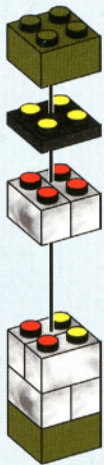

2



3



4

x4

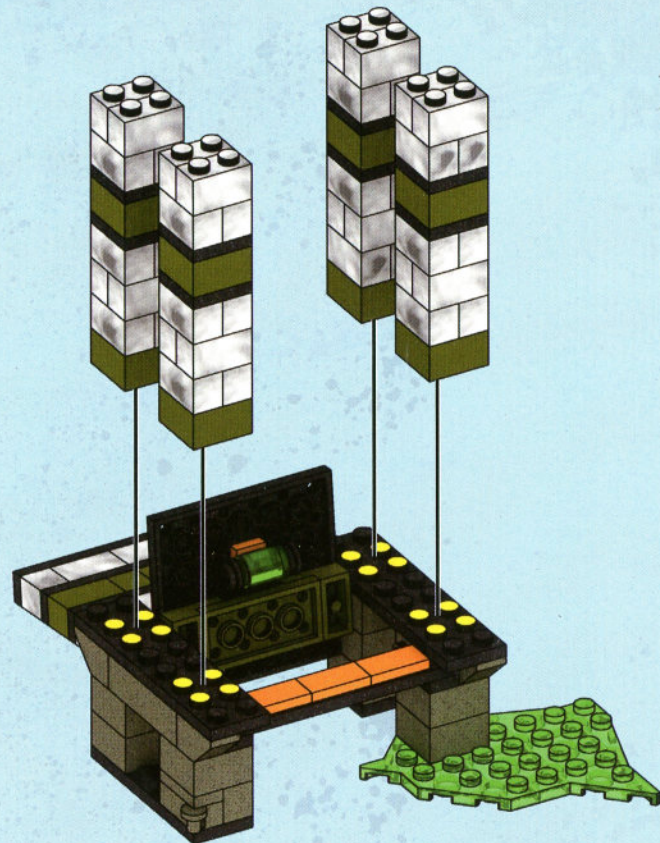

33



4x

34



8x

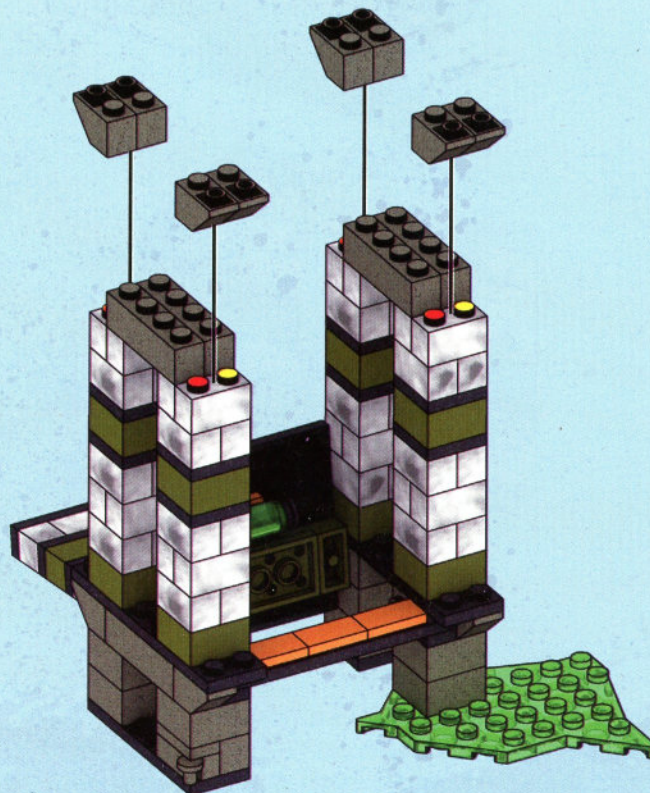
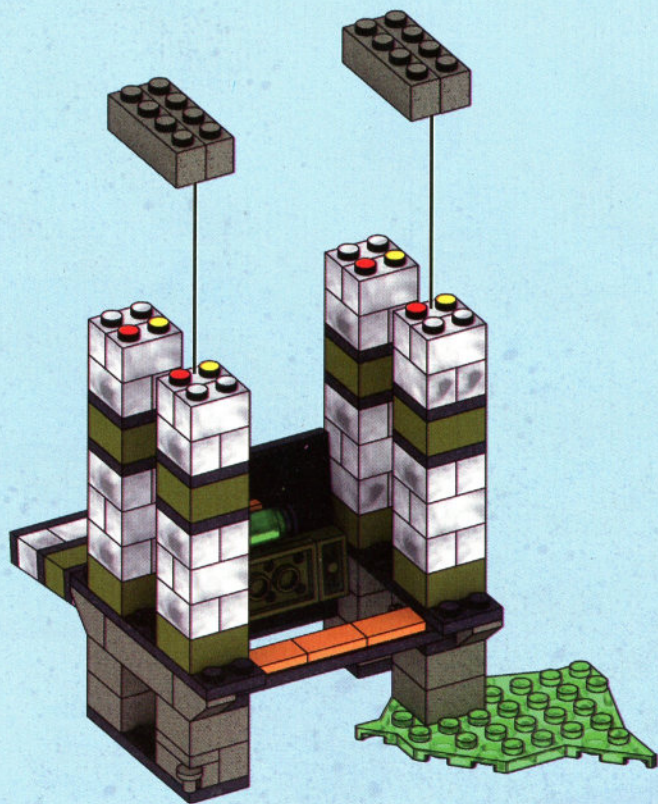

35



2x

2x

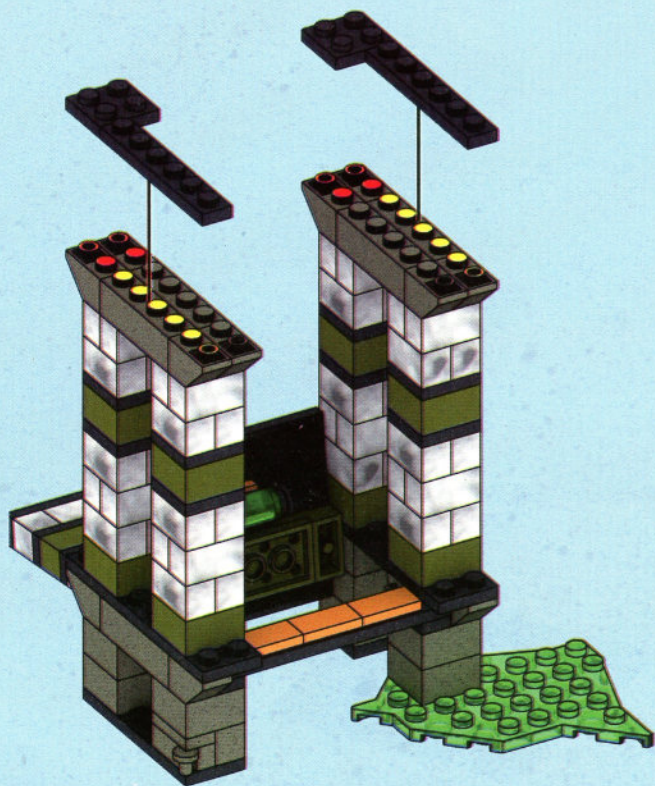

36



2x

2x

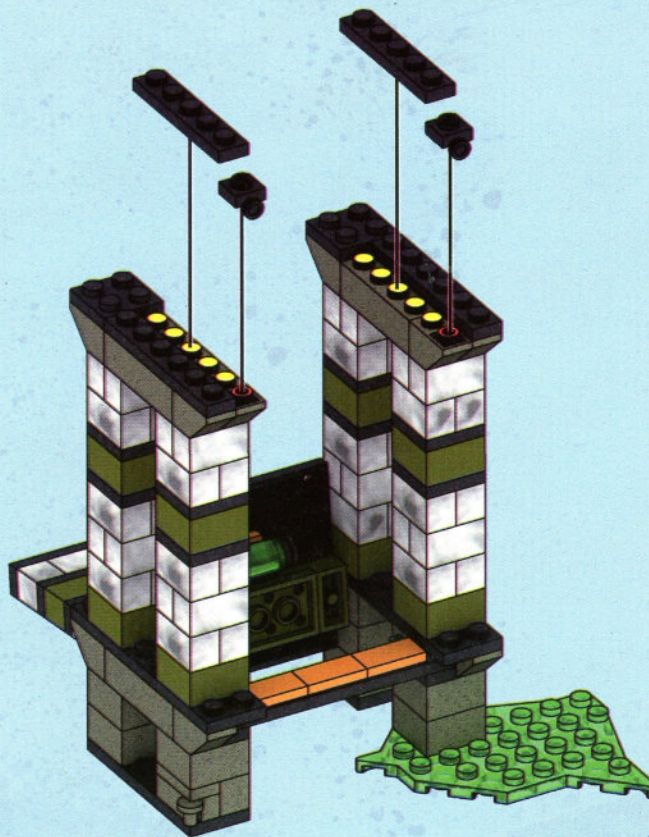

37



2x



1x

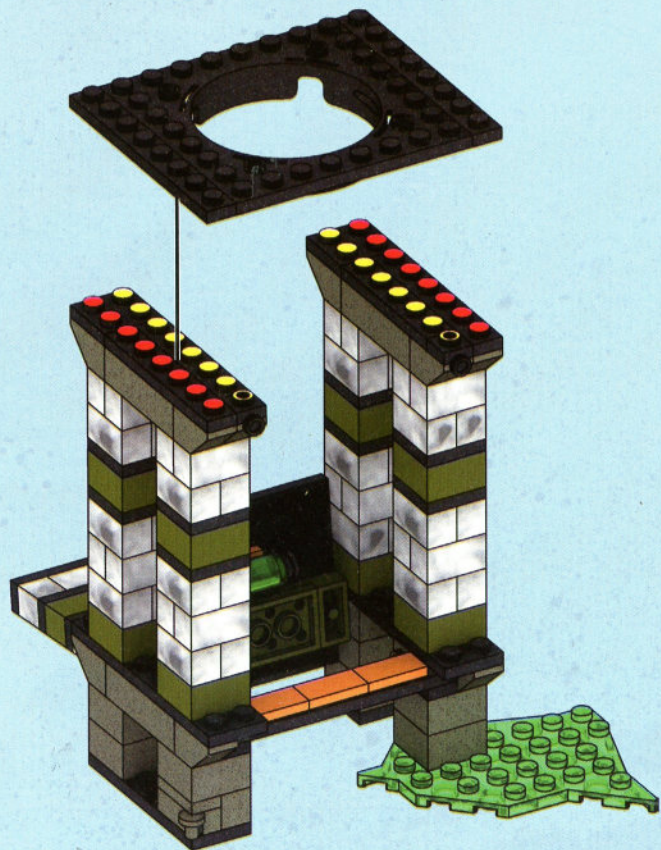

38



7x

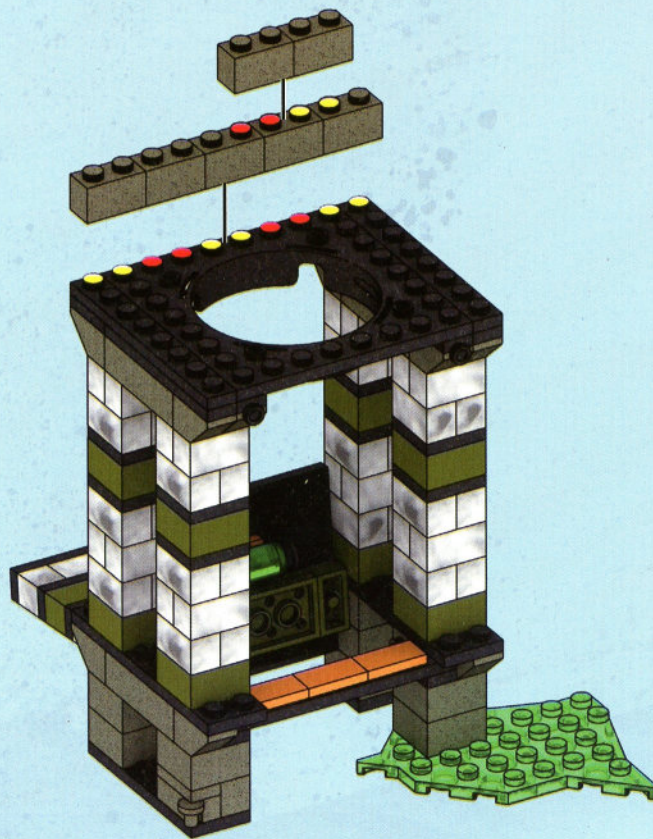

39



1x

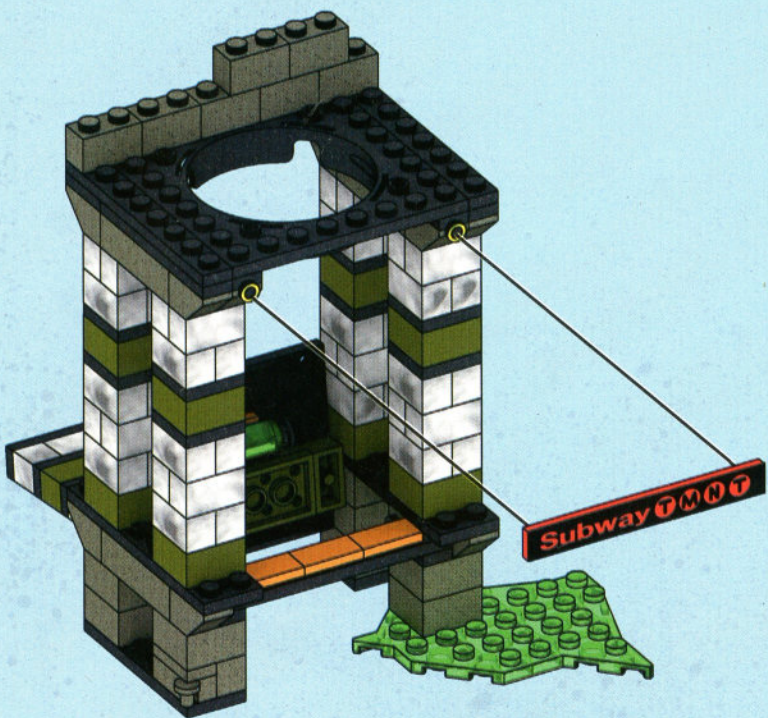

40



2x



4x



1x



1x

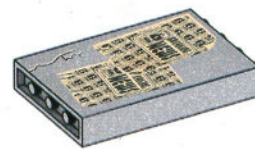

1x

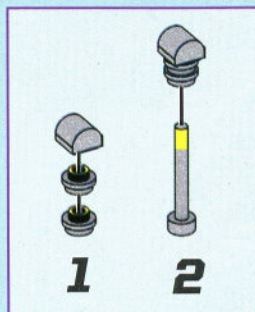

1

2

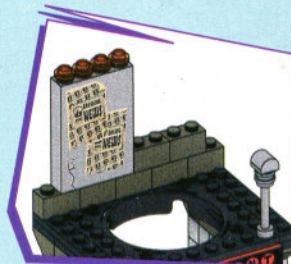
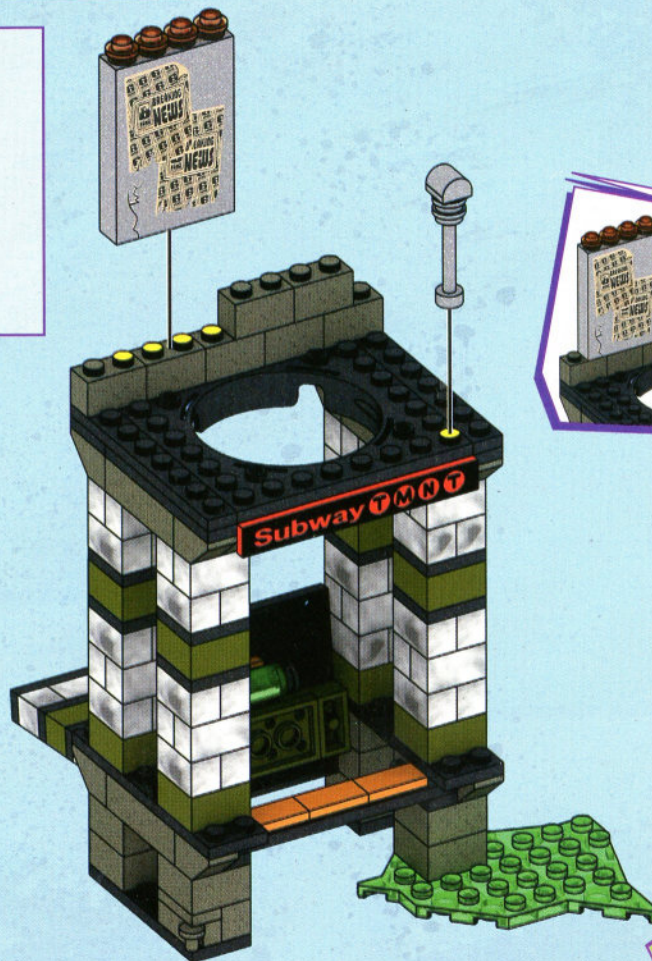
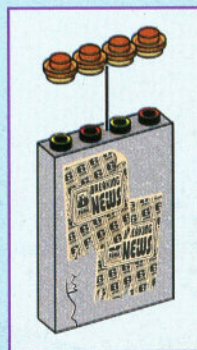





44



2x



1x



1x

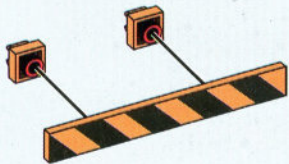

1

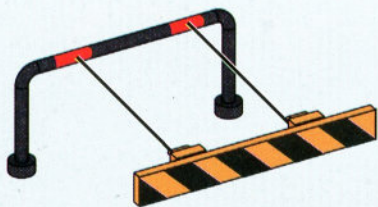

2

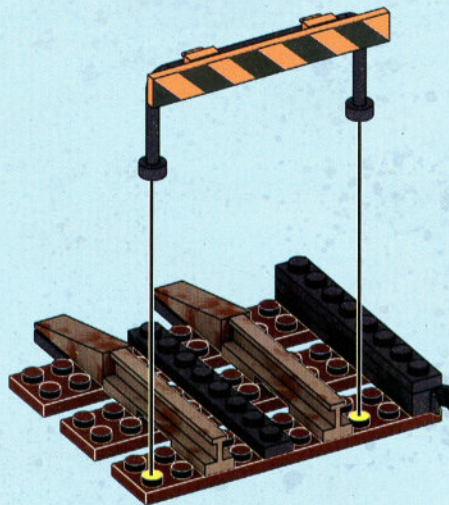

1

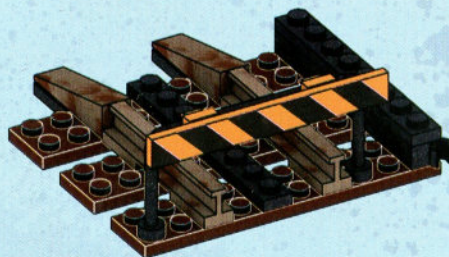

2



45



3x



1x



1x

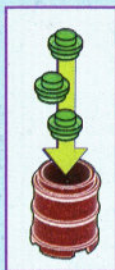

40

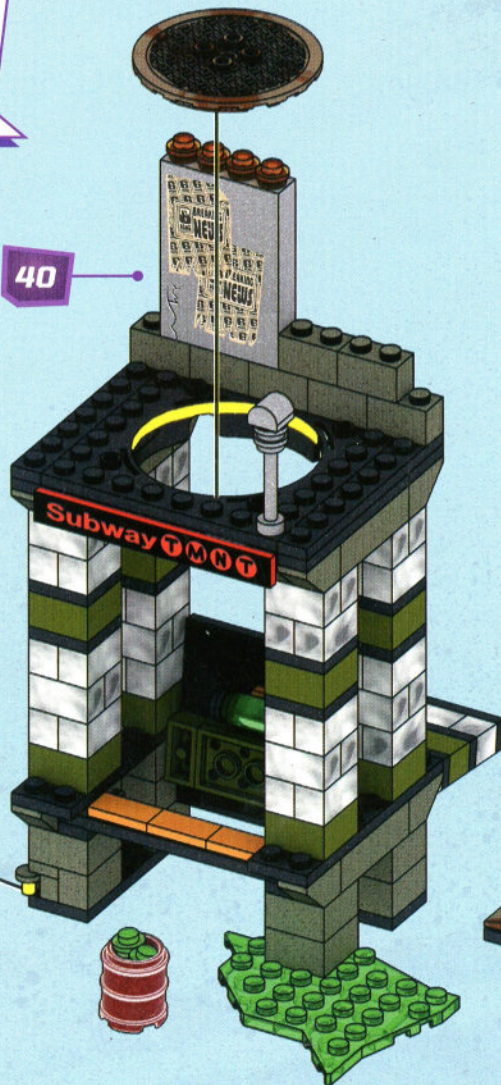

44

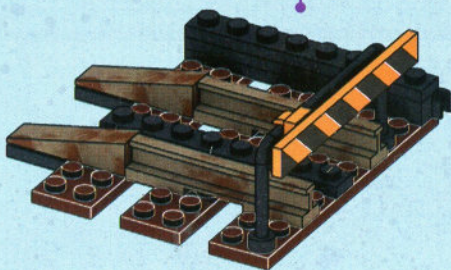

1

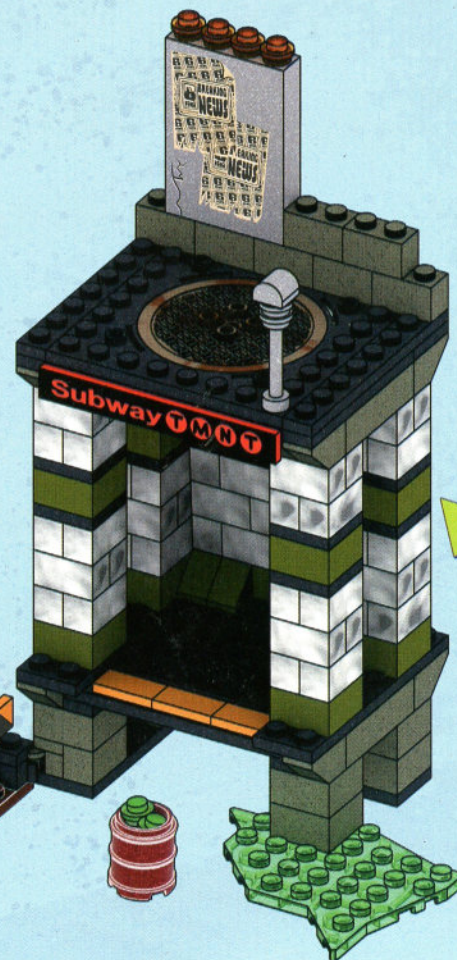
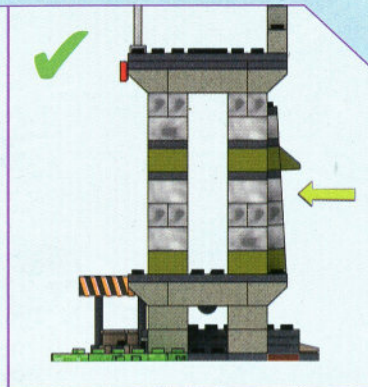
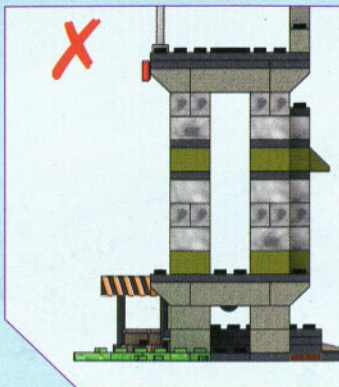

2

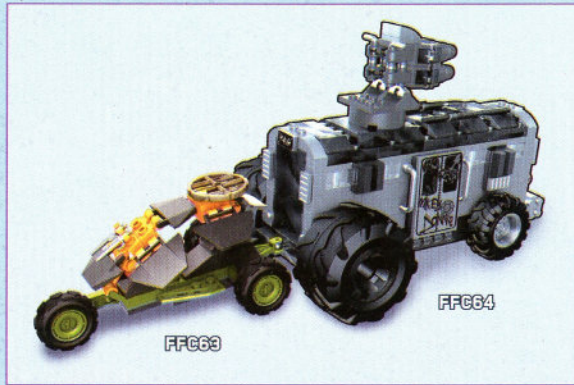

Each sold separately and subject to availability. / Tous vendus séparément. Certains produits peuvent ne pas être commercialisés. / Se venden por separado y están sujetos a disponibilidad. / Vendidos em separado e sujeitos à disponibilidade. / Ognuno in vendita separatamente secondo disponibilità. / Alle Artikel separat erhältlich. Einige Artikel werden nicht in allen Ländern vertrieben. / Sprzedawane oddzielnie w zależności od dostępności. / Per stuk verkrijgbaar en niet overal leverbaar. / Каждый продукт продается отдельно, в зависимости от наличия. / Sælges separat og så længe lager haves. / Alla delar säljs separat så långt lagret räcker. / Hver leke selges separat så langt lageret rekker. / Jokainen myydään erikseen, saatavuus voi vaihdella. / Το καθένα πωλείται ξεχωριστά και ανάλογα με τη διαθεσιμότητα. / Her birli ayrı ayrı ve stoklara bağlı olarak satılır. / 每件单独出售，并且视库存情况而定。 / それぞれ在庫状況に従って個別に販売されます。 / تباع كل منها على حدة وتخضع لتوفرها.

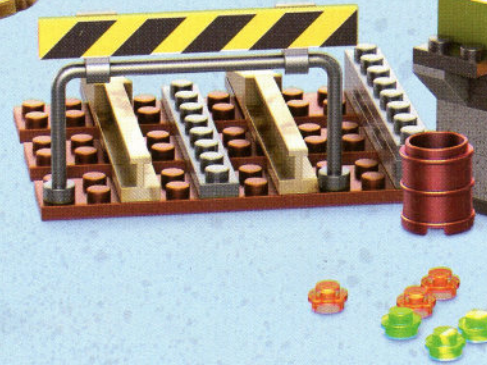

Warning: Do not aim at eyes or face. Only use projectiles supplied with this toy. Do not fire at point blank range.  
 Attention : Ne pas viser les yeux ou le visage. Ne pas utiliser d'autres projectiles que ceux fournis avec ce jouet. Ne pas tirer à bout portant.  
 Advertència: No apuntar hacia los ojos o la cara. Usar únicamente los proyectiles suministrados con este juguete. No disparar a quemarropa.  
 Atenção: Não apontar em direção aos olhos ou ao rosto. Usar apenas os projéteis fornecidos com este brinquedo. Não disparar à queima-roupa.  
 Avvertenza: Non mirare agli occhi o al viso. Usare solo i proiettili forniti con il giocattolo. Non sparare a distanza ravvicinata.  
 Achtung: Nicht auf Augen oder Gesicht zielen. Nur die zu diesem Spielzeug gehörenden Projektile verwenden. Nicht auf Menschen oder Tiere oder aus nächster Nähe zielen.  
 Ostrzeżenie: Nie celuj w oczy i twarz. Nie strzelaj pociskami innymi niż dostarczone z zabawką. Nie strzelaj z bliska.  
 Waarschuwing: niet op ogen of gezicht richten. Gebruik uitsluitend de bijgeleverde projectielen. Niet van te dichtbij afschieten.  
 Предупреждение: Не направляйте в глаза или лицо. Используйте только снаряды, входящие в комплект. Не стреляйте со слишком близкого расстояния.  
 Advarsel: Sigt ikke mod øjne eller ansigt. Brug kun de projektiler, som følger med legetøjet. Skyd ikke direkte på personer eller ting.  
 Varning: Sikta inte mot ögon eller ansikte. Använd endast projektiler som medföljer leksaken. Fyra inte av på mycket nära håll.  
 Advarsel: Du må ikke sikte mot øyne eller ansikt. Bruk bare prosjektilene som følger med leken. Ikke skyt på noe på kloss hold.  
 Varoitus: Älä tähtää silmiin eikä kasvoihin. Käytä ainoastaan tämän tuotteen mukana tulleita ammuksia. Älä ammu lähietäisyydeltä.  
 Προσοχή: Μην στοχεύετε στα μάτια ή στο πρόσωπο. Χρησιμοποιείτε μόνο τα βλήματα που περιλαμβάνονται. Μην στοχεύετε όταν δεν έχετε ορατότητα.  
 Uyarı: Göze veya yüze nişan almayın. Fırlatmak için yalnızca bu oyuncakla birlikte verilen objeleri kullanın. İnsanlara ve hayvanlara nişan almayın.  
 警告: 请勿对着眼睛或脸部发射。仅使用本玩具自带的抛射物。请勿近距离射击。  
 警告: 目や顔を狙わないでください。このおもちゃに同梱されている発射物のみを使用するようにしてください。到達可能な距離内で火を燃やさないでください。  
 تحذير: يجب عدم التصويب باتجاه العينين أو الوجه. يجب استخدام المقذوفات المزودة مع هذه اللعبة فقط. يجب عدم الإطلاق من مدى قريب.



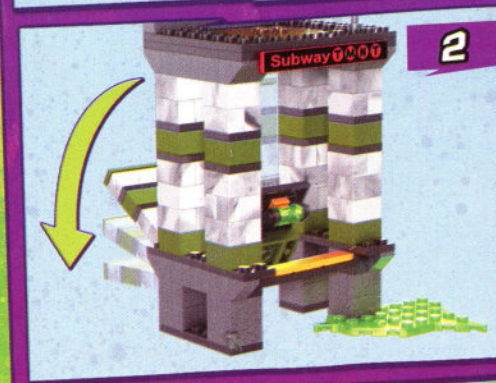
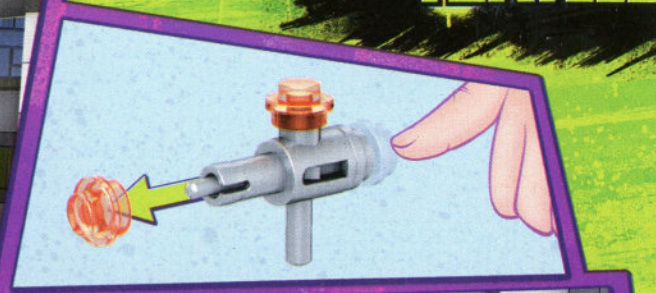

COLLECT & CONNECT! | COLLECTIONNE-LES ET COMBINE-LES!  
 ¡COLECCIONA Y CONECTA! | COLECCIONA E UNE! | COLLEZIONA  
 E COLLEGA! | ZUM SAMMELN UND VERBINDEN! | ZBIERAJ  
 ŁĄCZ! | VERZAMEL & COMBINEER! | СОБИРАЙ И СОЕДИНЯЙ!  
 ΚΑΝΤΕ ΣΟΥΠΕΡ ΣΥΛΛΟΓΗ & ΕΝΩΣΤΕ! | HEPSİNİ BİRİKTİR VE  
 BİRLEŞTİR! | اجمع ووصل!



FFC54

FFC55

DXY74

DXY15

DXY14

DXY05

DXY12

DXY13

FFC57

DXY06

Each sold separately and subject to availability. / Tous vendus séparément. Certains produits peuvent ne pas être commercialisés. / Se venden por separado y están sujetos a disponibilidad. / Vendidos em separado e sujeitos à disponibilidade. / Ognuno in vendita separatamente secondo disponibilità. / Alle Artikel separat erhältlich. Einige Artikel werden nicht in allen Ländern vertrieben. / Sprzedawane oddzielnie w zależności od dostępności. / Per stuk verkrijgbaar en niet overal leverbaar. / Каждый продукт продается отдельно, в зависимости от наличия. / Sælges separat og så længe lager haves. / Alla delar säljs separat så långt lagret räcker. / Hver leke selges separat så langt lageret rekker. / Jokainen myydään erikseen, saatavuus voi vaihdella. / Το καθένα πωλείται ξεχωριστά και ανάλογα με τη διαθεσιμότητα. / Her biri ayrı ayrı ve stoklara bağlı olarak satılır. / 每件单独出售，并且视库存情况而定。 / それぞれ在庫状況に従って個別に販売されます。 / تباع كل منها على حدة وتخضع لتوفرها.

nickelodeon

# TEENAGE MUTANT NINJA TURTLES

COLLECT THEM ALL! | COLLECTIONNE-LES  
TOUS! | ¡COLECCIONALOS! | COLECIONA!  
COLLEZIONALI TUTTI! | COOLER SPIELSPASS  
MIT ALLEN PRODUKTEN! | ZBIERZ WSZYSTKIE!  
| VERZAMEL ZE ALLEMAAL! | СОБЕРИ ИХ  
ВСЕ! | ΣΥΛΛΟΓΗ! | HEPSINI BIRIKTİR! | اجمعها كلها!



RAPH

FFC63



FISHFACE

FFC63



MIKEY

DXY05



SUPER  
SHREDDER

FFC64



ARMAGGON

DMX21/FDB65



CASEY  
JONES

FFC64



LEO

DMX21/FDB65



KRAANGROID

DXY14



MIKEY

DXY13



BEBOP

DXY15



RAPH

FFC55



LEO

DXY15



MIKEY

FFC54



SHREDDER

FFC57



DONNIE

DXY12



Each sold separately and subject to availability. / Tous vendus séparément. Certains produits peuvent ne pas être commercialisés. / Se venden por separado y están sujetos a disponibilidad. / Vendidos em separado e sujeitos à disponibilidade. / Ognuno in vendita separatamente secondo disponibilità. / Alle Artikel separat erhältlich. Einige Artikel werden nicht in allen Ländern vertrieben. / Sprzedawane oddzielnie w zależności od dostępności. / Per stuk verkrijgbaar en niet overall leverbaar. / Каждый продукт продается отдельно, в зависимости от наличия. / Sælges separat og så længe lager haves. / Alla delar säljs separat så långt lagret räcker. / Hver leke selges separat så langt lagret rekker. / Jokainen myydyään erikseen, saatavuus voi vaihdella. / Το καθένα πωλείται ξεχωριστά και ανάλογα με τη διαθεσιμότητα. / Her biri ayrı ayrı ve stoklara bağlı olarak satılır. / 每件单独出售，并且视库存情况而定。 / それぞれ在庫状況に従って個別に販売されます。 / يتباع كل منها على حدة وتخضع لتوفرها.

# MEGA CONSTRUX™

Build Beyond™

Au-delà de la construction!

¡Construye sin límites!

Mais do que Construção!

Costruisci oltre ogni limite!

Es gibt keine Grenzen!

Więcej niż budowanie!

Meer dan alleen bouwen!

Больше, чем конструктор!

Χτίσε έναν ολόκληρο κόσμο!

Hayallerini İnşa Et!

لنبني .. وأكثر!



▶ [play.megaconstrux.com](http://play.megaconstrux.com)

